

DRAWING NUMBER:	09-8024-X-XX
PRODUCT GROUP:	TERMINALS
SUB-GROUP:	COMMERCIAL NON-INSULATED TERMINALS
DESCRIPTION:	NON-INSULATED PC PIN TERMINAL

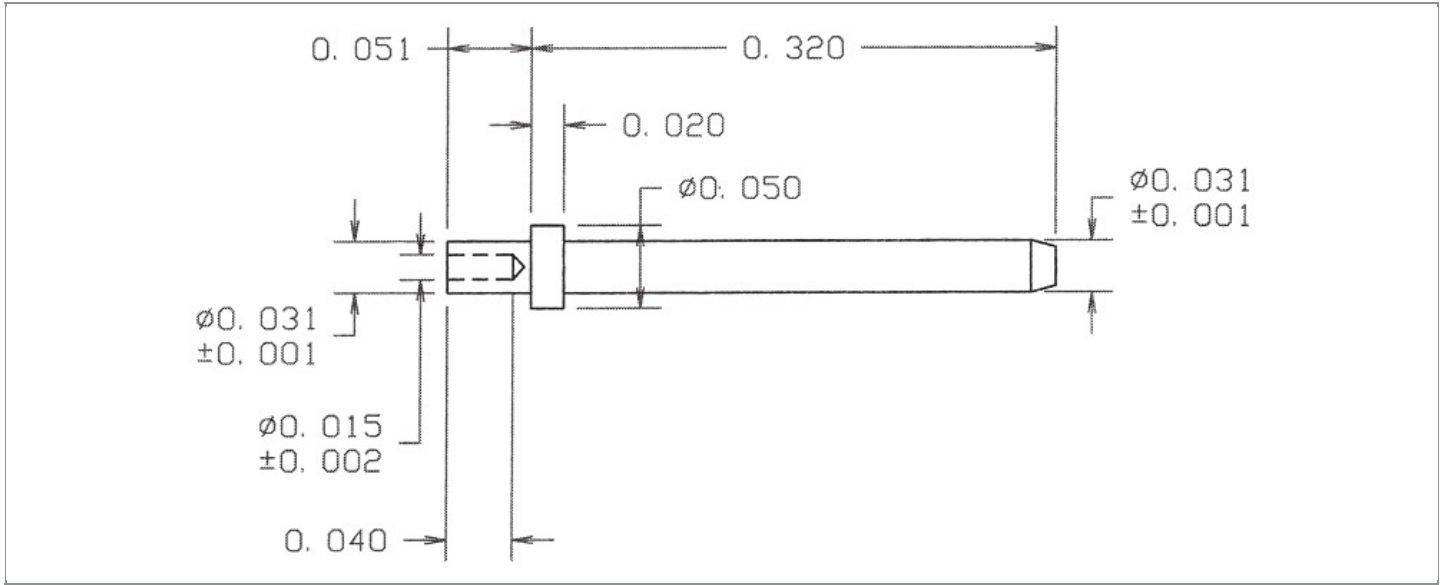

BOARD / PANEL MOUNTING METHOD	MOUNTING HOLE SIZE	DRILL SIZE	FEED THRU COMBINATION
SWAGE MOUNT	0.035" ± 0.001	#65	N/A

PART NO. STRUCTURE:

09-8024 - 1 - XX
 PART SERIES DIMENSION FINISH

MATERIAL OPTIONS:

09-8024-1-XX

COMPONENT	MATERIAL	MATERIAL AND SPECIFICATION
TERMINAL	BRASS	BRASS PER ASTM B16, ALLOY C36000, 1/2 HARD

DIMENSION OPTIONS:

09-8024-1-XX

DIMENSION	A	D	PIN DIAMETER	OVERALL LENGTH	SHANK LENGTH (L)	BOARD/PANEL THICKNESS
1	N/A	N/A	0.031" ± 0.001	0.371"	0.051"	1/32"

FINISH - PLATING OPTIONS:

09-8024-1-XX

FINISH CODE	COMPONENT	FINISH	FINISH AND SPECIFICATION
01	TERMINAL	SILVER	0.000300"MIN. SILVER PER ASTM B700, TYPE 2, GRADE D WITH A NON-CHROMATE PRESERVATIVE TREATMENT
03	TERMINAL	GOLD	0.000010"MIN. GOLD PER ASTM B488, TYPE II, CODE C OVER 0.000050"MIN. NICKEL PER SAE-AMS-QQ-N-290
035	TERMINAL	GOLD	0.000050"MIN. GOLD PER ASTM B488, TYPE II, CODE C OVER 0.000050"MIN. NICKEL PER SAE-AMS-QQ-N-290
04	TERMINAL	ELECTRO-TIN	0.000300"MIN. ELECTRO-TIN PER ASTM B545 OVER 0.000100"MIN. COPPER PER SAE-AMS-2418
044	TERMINAL	BRIGHT ELECTRO-TIN	0.000300"MIN. BRIGHT ELECTRO-TIN PER ASTM B545 OVER 0.000100"MIN. COPPER PER SAE-AMS-2418
05	TERMINAL	ELECTRO-SOLDER	0.000300"MIN. ELECTRO-SOLDER PER SAE-AMS-P-81728 OVER 0.000100"MIN. COPPER PER SAE-AMS-2418
088	TERMINAL	BRIGHT TIN-LEAD	0.000300"MIN. BRIGHT TIN-LEAD (Sn93%-Pb7%) PER ASTM B545 OVER 0.000100"MIN. COPPER PER SAE-AMS-2418

TOLERANCES:*

DECIMAL	FRACTIONAL	ANGULAR	DRAWING ORIGATION DATE	LAST MODIFICATION DATE
± 0.005	± 1/64	± 5 °	1/20/2000	3/1/2017

*All dimensions are in inches.

RoHS COMPLIANCE:

09-8024-1-XX

PART NUMBER	RoHS COMPLIANT
09-8024-1-01	YES
09-8024-1-03	YES
09-8024-1-035	YES
09-8024-1-04	YES
09-8024-1-044	YES
09-8024-1-05	NO
09-8024-1-088	NO

TOOLING:

INSTALLATION TOOL: ARBOR PRESS	INSTALLATION TOOL: ANVIL (ARBOR PRESS OPERATED)	INSTALLATION TOOL: PRESS-FIT / ROLL SWAGE / RIVET PUNCH (ARBOR PRESS OPERATED)	INSTALLATION TOOL: FLARE SWAGE PUNCH (ARBOR PRESS OPERATED)
TM1	TA50-31-20	TP30-20	TFLP90-150

NOTES:

DATASHEET NOTES
N/A

Continued on next page...

NOTES CONTINUED:

INSTRUCTION NOTES

SEE GENERAL SWAGING INSTALLATION INSTRUCTION ON CONCORD ELECTRONICS' WEBSITE WWW.CONCORD-ELECTRONICS.COM.
