

|                        |                                |
|------------------------|--------------------------------|
| <b>DRAWING NUMBER:</b> | <b>1100R-42-XXXX</b>           |
| <b>PRODUCT GROUP:</b>  | TERMINALS                      |
| <b>SUB-GROUP:</b>      | COMMERCIAL INSULATED TERMINALS |
| <b>DESCRIPTION:</b>    | PTFE INSULATED PIN TERMINAL    |

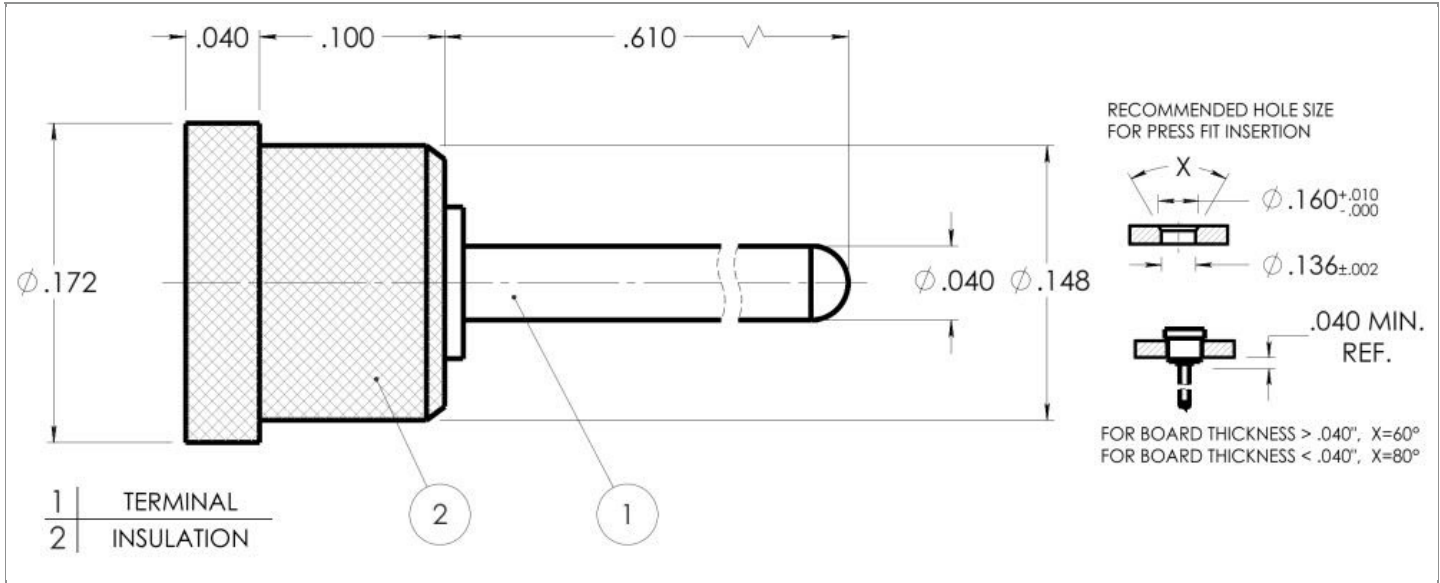

| OVERALL LENGTH   | PIN DIAMETER            | FEED THRU COMBINATION | BOARD / PANEL MOUNTING METHOD |
|------------------|-------------------------|-----------------------|-------------------------------|
| 0.750"           | 0.040" ± 0.005          | N/A                   | PRESS FIT                     |
| SHANK LENGTH (L) | BOARD / PANEL THICKNESS | MOUNTING HOLE SIZE    | DRILL SIZE                    |
| N/A              | UP TO 1/16"             | 0.136" ± 0.002        | #29                           |

**PART NO. STRUCTURE:**

|              |   |           |   |           |                  |
|--------------|---|-----------|---|-----------|------------------|
| <b>1100R</b> | - | <b>42</b> | - | <b>XX</b> | <b>XX</b>        |
| PART SERIES  |   | DIMENSION |   | FINISH    | INSULATION COLOR |

**MATERIAL OPTIONS:**

**1100R-42-XXXX**

| COMPONENT         | MATERIAL | MATERIAL AND SPECIFICATION                 |
|-------------------|----------|--|
| TERMINAL          | BRASS    | BRASS PER ASTM B16, ALLOY C36000, 1/2 HARD |
| BASE/METAL SLEEVE | N/A      | N/A  |
| INSULATION*       | PTFE     | PTFE PER ASTM D1710                        |
| NUT               | N/A      | N/A  |
| WASHER            | N/A      | N/A  |

\*For Insulation color, please see INSULATION COLOR OPTIONS on Page 3

## FINISH - PLATING OPTIONS:

1100R-42-XXXX

| FINISH CODE | COMPONENT         | FINISH             | FINISH AND SPECIFICATION  |
|-------------|-------------------|--------------------|---|
| 01          | TERMINAL          | SILVER             | 0.000300"MIN. SILVER PER ASTM B700, TYPE 2, GRADE D WITH A NON-CHROMATE PRESERVATIVE TREATMENT          |
|             | BASE/METAL SLEEVE | N/A                | N/A   |
|             | NUT               | N/A                | N/A   |
|             | WASHER            | N/A                | N/A   |
| 03          | TERMINAL          | GOLD               | 0.00010"MIN. GOLD PER ASTM B488, TYPE II, CODE C OVER 0.000100"MIN. NICKEL PER SAE-AMS-QQ-N-290         |
|             | BASE/METAL SLEEVE | N/A                | N/A   |
|             | NUT               | N/A                | N/A   |
|             | WASHER            | N/A                | N/A   |
| 04          | TERMINAL          | ELECTRO-TIN        | 0.000300"MIN. ELECTRO-TIN PER ASTM B545 OVER 0.000100"MIN. NICKEL PER SAE-AMS-QQ-N-290                  |
|             | BASE/METAL SLEEVE | N/A                | N/A   |
|             | NUT               | N/A                | N/A   |
|             | WASHER            | N/A                | N/A   |
| 044         | TERMINAL          | BRIGHT ELECTRO-TIN | 0.000300"MIN. BRIGHT ELECTRO-TIN PER ASTM B545 OVER 0.000100"MIN. NICKEL PER SAE-AMS-QQ-N-290           |
|             | BASE/METAL SLEEVE | N/A                | N/A   |
|             | NUT               | N/A                | N/A   |
|             | WASHER            | N/A                | N/A   |
| 05          | TERMINAL          | ELECTRO-SOLDER     | 0.000300"MIN. ELECTRO-SOLDER PER SAE-AMS-P-81728 OVER 0.000100"MIN. NICKEL PER SAE-AMS-QQ-N-290         |
|             | BASE/METAL SLEEVE | N/A                | N/A   |
|             | NUT               | N/A                | N/A   |
|             | WASHER            | N/A                | N/A   |
| 088         | TERMINAL          | BRIGHT TIN-LEAD    | 0.000300"MIN. BRIGHT TIN-LEAD (Sn93%-Pb7%) PER ASTM B545 OVER 0.000100"MIN. NICKEL PER SAE-AMS-QQ-N-290 |
|             | BASE/METAL SLEEVE | N/A                | N/A   |
|             | NUT               | N/A                | N/A   |
|             | WASHER            | N/A                | N/A   |

INSULATION COLOR OPTIONS:

1100R-42-XX **XX**

| INSULATION COLOR | BLACK | BLUE | BROWN | GRAY | GREEN | ORANGE | RED | VIOLET | WHITE | YELLOW |
|------------------|-------|------|-------|------|-------|--------|-----|--------|-------|--------|
| COLOR CODE NO.   | 10    | 16   | 11    | 18   | 15    | 13     | 12  | 17     | 19    | 14     |

TOLERANCES:\*

| DECIMAL | FRACTIONAL | ANGULAR | DRAWING ORIGATION DATE | LAST MODIFICATION DATE |
|---------|------------|---------|------------------------|------------------------|
| ± 0.005 | ± 1/64     | ± 5 °   | 8/28/2003              | 1/15/2019              |

\*All dimensions are in inches.

RoHS COMPLIANCE:

1100R-42-01XX

| PART NUMBER   | RoHS COMPLIANT |
|---------------|----------------|
| 1100R-42-0110 | YES            |
| 1100R-42-0111 | NO             |
| 1100R-42-0112 | NO             |
| 1100R-42-0113 | NO             |
| 1100R-42-0114 | NO             |
| 1100R-42-0115 | YES            |
| 1100R-42-0116 | YES            |
| 1100R-42-0117 | YES            |
| 1100R-42-0118 | NO             |
| 1100R-42-0119 | YES            |

1100R-42-03XX

| PART NUMBER   | RoHS COMPLIANT |
|---------------|----------------|
| 1100R-42-0310 | YES            |
| 1100R-42-0311 | NO             |
| 1100R-42-0312 | NO             |
| 1100R-42-0313 | NO             |
| 1100R-42-0314 | NO             |
| 1100R-42-0315 | YES            |
| 1100R-42-0316 | YES            |
| 1100R-42-0317 | YES            |
| 1100R-42-0318 | NO             |
| 1100R-42-0319 | YES            |

1100R-42-04XX

| PART NUMBER   | RoHS COMPLIANT |
|---------------|----------------|
| 1100R-42-0410 | YES            |
| 1100R-42-0411 | NO             |
| 1100R-42-0412 | NO             |
| 1100R-42-0413 | NO             |
| 1100R-42-0414 | NO             |
| 1100R-42-0415 | YES            |
| 1100R-42-0416 | YES            |
| 1100R-42-0417 | YES            |
| 1100R-42-0418 | NO             |
| 1100R-42-0419 | YES            |

1100R-42-044XX

| PART NUMBER    | RoHS COMPLIANT |
|----------------|----------------|
| 1100R-42-04410 | YES            |
| 1100R-42-04411 | NO             |
| 1100R-42-04412 | NO             |
| 1100R-42-04413 | NO             |
| 1100R-42-04414 | NO             |
| 1100R-42-04415 | YES            |
| 1100R-42-04416 | YES            |
| 1100R-42-04417 | YES            |
| 1100R-42-04418 | NO             |
| 1100R-42-04419 | YES            |

1100R-42-05XX

| PART NUMBER   | RoHS COMPLIANT |
|---------------|----------------|
| 1100R-42-0510 | NO             |
| 1100R-42-0511 | NO             |
| 1100R-42-0512 | NO             |
| 1100R-42-0513 | NO             |
| 1100R-42-0514 | NO             |
| 1100R-42-0515 | NO             |
| 1100R-42-0516 | NO             |
| 1100R-42-0517 | NO             |
| 1100R-42-0518 | NO             |
| 1100R-42-0519 | NO             |

1100R-42-088XX

| PART NUMBER    | RoHS COMPLIANT |
|----------------|----------------|
| 1100R-42-08810 | NO             |
| 1100R-42-08811 | NO             |
| 1100R-42-08812 | NO             |
| 1100R-42-08813 | NO             |
| 1100R-42-08814 | NO             |
| 1100R-42-08815 | NO             |
| 1100R-42-08816 | NO             |
| 1100R-42-08817 | NO             |
| 1100R-42-08818 | NO             |
| 1100R-42-08819 | NO             |

TOOLING:

| INSTALLATION TOOL:<br>ARBOR PRESS | INSTALLATION TOOL:<br>ANVIL<br>(ARBOR PRESS OPERATED) | INSTALLATION TOOL:<br>PRESS-FIT / ROLL SWAGE / RIVET PUNCH<br>(ARBOR PRESS OPERATED) | INSTALLATION TOOL:<br>PRESS-FIT<br>(HAND OPERATED) |
|-----------------------------------|---|--|--|
| TM1                               | TA1100R-42  | TPI1100R-42  | TTI1100R-42  |

NOTES:

| DATASHEET NOTES |
|-----------------|
|-----------------|

N/A

| INSTRUCTION NOTES |
|-------------------|
|-------------------|

SEE GENERAL PRESS FIT INSTALLATION INSTRUCTION ON CONCORD ELECTRONICS' WEBSITE [WWW.CONCORD-ELECTRONICS.COM](http://WWW.CONCORD-ELECTRONICS.COM).