

DRAWING NUMBER:	1110-21M-XXXXZ
PRODUCT GROUP:	TERMINALS
SUB-GROUP:	MILITARY INSULATED TERMINALS
DESCRIPTION:	PTFE INSULATED FEED THRU (PIN/PIN) TERMINAL

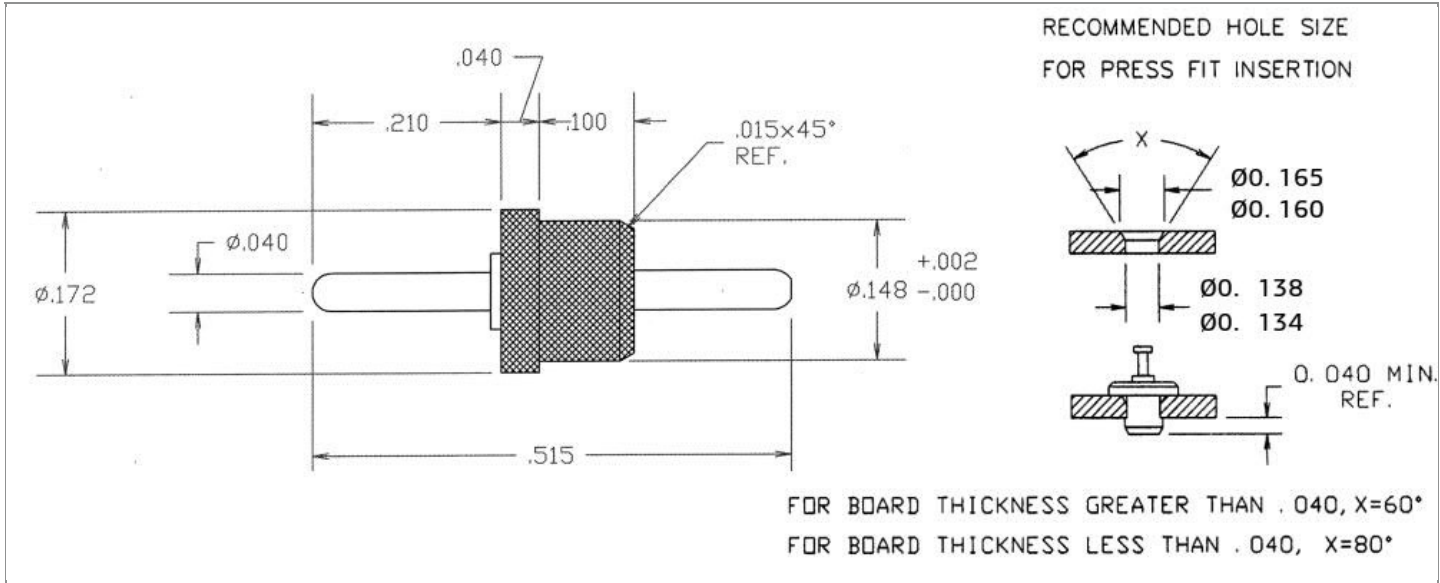

PIN DIAMETER	OVERALL LENGTH	MOUNTING ORIENTATION	BOARD / PANEL MOUNTING METHOD
0.040" ± 0.005	0.515"	VERTICAL	PRESS FIT

BOARD / PANEL THICKNESS	MOUNTING HOLE SIZE	DRILL SIZE	FEED THRU COMBINATION
UP TO 1/16"	0.136" ± 0.002	#29	PIN/PIN

PART NO. STRUCTURE:*

1110	-	21M	-	XX	XX
PART SERIES		DIMENSION		FINISH	INSULATION COLOR

*If applicable, "Z" at the end of a PART NO. STRUCTURE indicates TERMINAL MATERIAL TYPE.

MATERIAL OPTIONS:

1110-21M-XXXXZ

COMPONENT	MATERIAL	MATERIAL AND SPECIFICATION
TERMINAL	PHOSPHOR BRONZE	PHOSPHOR BRONZE PER ASTM B139, ALLOY C54400
BASE/METAL SLEEVE	N/A	N/A
INSULATION*	PTFE	PTFE PER ASTM D1710
NUT	N/A	N/A
WASHER	N/A	N/A

*For Insulation color, please see INSULATION COLOR OPTIONS on Page 2

FINISH - PLATING OPTIONS:

1110-21M-XXXXZ

FINISH CODE	COMPONENT	FINISH	FINISH AND SPECIFICATION
05	TERMINAL	ELECTRO-SOLDER	0.000300"MIN. ELECTRO-SOLDER PER SAE-AMS-P-81728 OVER 0.000100"MIN. COPPER PER SAE-AMS-2418
	BASE/METAL SLEEVE	N/A	N/A
	NUT	N/A	N/A
	WASHER	N/A	N/A
088	TERMINAL	BRIGHT TIN-LEAD	0.000300"MIN. BRIGHT TIN-LEAD (Sn93%-Pb7%) PER ASTM B545 OVER 0.000100"MIN. COPPER PER SAE-AMS-2418
	BASE/METAL SLEEVE	N/A	N/A
	NUT	N/A	N/A
	WASHER	N/A	N/A
095	TERMINAL	HOT SOLDER DIP	0.000100"MIN. HOT SOLDER DIP USING Sn60 PER IPC-J-STD-006 OVER 0.000100"MIN. COPPER PER SAE-AMS-2418
	BASE/METAL SLEEVE	N/A	N/A
	NUT	N/A	N/A
	WASHER	N/A	N/A

INSULATION COLOR OPTIONS:

1110-21M-XXXXZ

INSULATION COLOR	BLACK	BLUE	BROWN	GRAY	GREEN	ORANGE	RED	VIOLET	WHITE	YELLOW
COLOR CODE NO.	10	16	11	18	15	13	12	17	19	14

TOLERANCES:*

DECIMAL	FRACTIONAL	ANGULAR	DRAWING ORIGINATION DATE	LAST MODIFICATION DATE
± 0.015	N/A	± 3 °	5/28/2004	3/1/2017

*All dimensions are in inches.

RoHS COMPLIANCE:

1110-21M-05XXZ

PART NUMBER	RoHS COMPLIANT
1110-21M-0510Z	NO
1110-21M-0511Z	NO
1110-21M-0512Z	NO
1110-21M-0513Z	NO
1110-21M-0514Z	NO
1110-21M-0515Z	NO
1110-21M-0516Z	NO
1110-21M-0517Z	NO
1110-21M-0518Z	NO
1110-21M-0519Z	NO

1110-21M-088XXZ

PART NUMBER	RoHS COMPLIANT
1110-21M-08810Z	NO
1110-21M-08811Z	NO
1110-21M-08812Z	NO
1110-21M-08813Z	NO
1110-21M-08814Z	NO
1110-21M-08815Z	NO
1110-21M-08816Z	NO
1110-21M-08817Z	NO
1110-21M-08818Z	NO
1110-21M-08819Z	NO

1110-21M-095XXZ

PART NUMBER	RoHS COMPLIANT
1110-21M-09510Z	NO
1110-21M-09511Z	NO
1110-21M-09512Z	NO
1110-21M-09513Z	NO
1110-21M-09514Z	NO
1110-21M-09515Z	NO
1110-21M-09516Z	NO
1110-21M-09517Z	NO
1110-21M-09518Z	NO
1110-21M-09519Z	NO

MILITARY REFERENCE SPECIFICATIONS:

1110-21M-05XXZ

PART NUMBER	MIL SPECIFICATION	MIL PART NUMBER	COMMERCIAL ITEM DESCRIPTION (CID) SPECIFICATION	CID PART NUMBER
1110-21M-0510Z	MIL-T-55155/03	M55155/030B02 (FT030B02Z)	A-A-59126/03	AA59126/030B02
1110-21M-0511Z	MIL-T-55155/03	M55155/031B02 (FT031B02Z)	A-A-59126/03	AA59126/031B02
1110-21M-0512Z	MIL-T-55155/03	M55155/032B02 (FT032B02Z)	A-A-59126/03	AA59126/032B02
1110-21M-0513Z	MIL-T-55155/03	M55155/033B02 (FT033B02Z)	A-A-59126/03	AA59126/033B02
1110-21M-0514Z	MIL-T-55155/03	M55155/034B02 (FT034B02Z)	A-A-59126/03	AA59126/034B02
1110-21M-0515Z	MIL-T-55155/03	M55155/035B02 (FT035B02Z)	A-A-59126/03	AA59126/035B02
1110-21M-0516Z	MIL-T-55155/03	M55155/036B02 (FT036B02Z)	A-A-59126/03	AA59126/036B02
1110-21M-0517Z	MIL-T-55155/03	M55155/037B02 (FT037B02Z)	A-A-59126/03	AA59126/037B02
1110-21M-0518Z	MIL-T-55155/03	M55155/038B02 (FT038B02Z)	A-A-59126/03	AA59126/038B02
1110-21M-0519Z	MIL-T-55155/03	M55155/039B02 (FT039B02Z)	A-A-59126/03	AA59126/039B02

1110-21M-088XXZ

PART NUMBER	MIL SPECIFICATION	MIL PART NUMBER	COMMERCIAL ITEM DESCRIPTION (CID) SPECIFICATION	CID PART NUMBER
1110-21M-08810Z	MIL-T-55155/03	M55155/030D02	A-A-59126/03	AA59126/030D02
1110-21M-08811Z	MIL-T-55155/03	M55155/031D02	A-A-59126/03	AA59126/031D02
1110-21M-08812Z	MIL-T-55155/03	M55155/032D02	A-A-59126/03	AA59126/032D02
1110-21M-08813Z	MIL-T-55155/03	M55155/033D02	A-A-59126/03	AA59126/033D02
1110-21M-08814Z	MIL-T-55155/03	M55155/034D02	A-A-59126/03	AA59126/034D02

Continued on next page...

MILITARY REFERENCE SPECIFICATIONS CONTINUED:

1110-21M-088XXZ

PART NUMBER	MIL SPECIFICATION	MIL PART NUMBER	COMMERCIAL ITEM DESCRIPTION (CID) SPECIFICATION	CID PART NUMBER
1110-21M-08815Z	MIL-T-55155/03	M55155/035D02	A-A-59126/03	AA59126/035D02
1110-21M-08816Z	MIL-T-55155/03	M55155/036D02	A-A-59126/03	AA59126/036D02
1110-21M-08817Z	MIL-T-55155/03	M55155/037D02	A-A-59126/03	AA59126/037D02
1110-21M-08818Z	MIL-T-55155/03	M55155/038D02	A-A-59126/03	AA59126/038D02
1110-21M-08819Z	MIL-T-55155/03	M55155/039D02	A-A-59126/03	AA59126/039D02

1110-21M-095XXZ

PART NUMBER	MIL SPECIFICATION	MIL PART NUMBER	COMMERCIAL ITEM DESCRIPTION (CID) SPECIFICATION	CID PART NUMBER
1110-21M-09510Z	MIL-T-55155/03	M55155/030C02	A-A-59126/03	AA59126/030C02
1110-21M-09511Z	MIL-T-55155/03	M55155/031C02	A-A-59126/03	AA59126/031C02
1110-21M-09512Z	MIL-T-55155/03	M55155/032C02	A-A-59126/03	AA59126/032C02
1110-21M-09513Z	MIL-T-55155/03	M55155/033C02	A-A-59126/03	AA59126/033C02
1110-21M-09514Z	MIL-T-55155/03	M55155/034C02	A-A-59126/03	AA59126/034C02
1110-21M-09515Z	MIL-T-55155/03	M55155/035C02	A-A-59126/03	AA59126/035C02
1110-21M-09516Z	MIL-T-55155/03	M55155/036C02	A-A-59126/03	AA59126/036C02
1110-21M-09517Z	MIL-T-55155/03	M55155/037C02	A-A-59126/03	AA59126/037C02
1110-21M-09518Z	MIL-T-55155/03	M55155/038C02	A-A-59126/03	AA59126/038C02
1110-21M-09519Z	MIL-T-55155/03	M55155/039C02	A-A-59126/03	AA59126/039C02

TOOLING:

INSTALLATION TOOL: ARBOR PRESS	INSTALLATION TOOL: ANVIL (ARBOR PRESS OPERATED)	INSTALLATION TOOL: PRESS-FIT / ROLL SWAGE / RIVET PUNCH (ARBOR PRESS OPERATED)	INSTALLATION TOOL: PRESS-FIT (HAND OPERATED)
TM1	TA1110-21	TPI1110-21	TTI1110-21

NOTES:

DATASHEET NOTES

N/A

INSTRUCTION NOTES

SEE GENERAL PRESS FIT INSTALLATION INSTRUCTION ON CONCORD ELECTRONICS' WEBSITE WWW.CONCORD-ELECTRONICS.COM.