

DRAWING NUMBER:	1110-16M-XXXX
PRODUCT GROUP:	TERMINALS
SUB-GROUP:	MILITARY INSULATED TERMINALS
DESCRIPTION:	PTFE INSULATED FEED THRU (PIN/PIN) TERMINAL

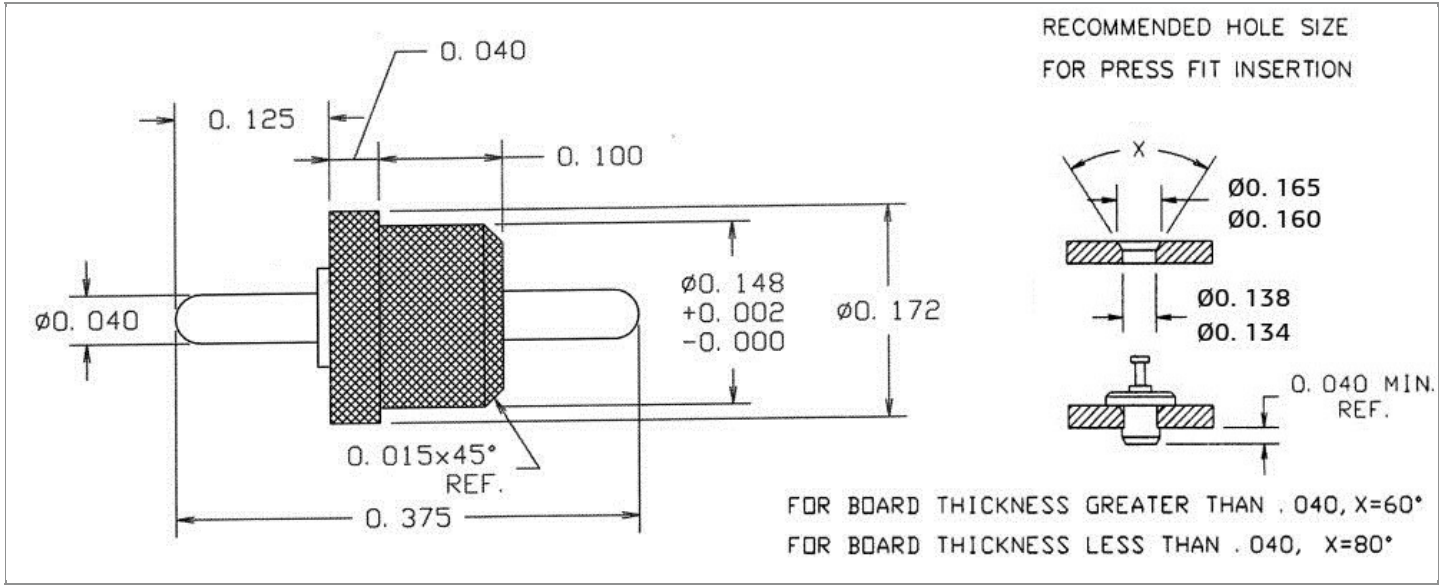

PIN DIAMETER	OVERALL LENGTH	MOUNTING ORIENTATION	BOARD / PANEL MOUNTING METHOD
0.040" ± 0.005	0.375"	VERTICAL	PRESS FIT

BOARD / PANEL THICKNESS	MOUNTING HOLE SIZE	DRILL SIZE	FEED THRU COMBINATION
UP TO 1/16"	0.136" ± 0.002	#29	PIN/PIN

PART NO. STRUCTURE:*

1110	-	16M	-	XX	XX
PART SERIES		DIMENSION		FINISH	INSULATION COLOR

*If applicable, "Z" at the end of a PART NO. STRUCTURE indicates TERMINAL MATERIAL TYPE.

MATERIAL OPTIONS:

1110-16M-XXXX

COMPONENT	MATERIAL	MATERIAL AND SPECIFICATION
TERMINAL	BRASS	BRASS PER ASTM B16, ALLOY C36000, 1/2 HARD
BASE/METAL SLEEVE	N/A	N/A
INSULATION*	PTFE	PTFE PER ASTM D1710
NUT	N/A	N/A
WASHER	N/A	N/A

*For Insulation color, please see INSULATION COLOR OPTIONS on Page 2

FINISH - PLATING OPTIONS:

1110-16M-XXXX

FINISH CODE	COMPONENT	FINISH	FINISH AND SPECIFICATION
05	TERMINAL	ELECTRO-SOLDER	0.000300"MIN. ELECTRO-SOLDER PER SAE-AMS-P-81728 OVER 0.000100"MIN. COPPER PER SAE-AMS-2418
	BASE/METAL SLEEVE	N/A	N/A
	NUT	N/A	N/A
	WASHER	N/A	N/A
088	TERMINAL	BRIGHT TIN-LEAD	0.000300"MIN. BRIGHT TIN-LEAD (Sn93%-Pb7%) PER ASTM B545 OVER 0.000100"MIN. COPPER PER SAE-AMS-2418
	BASE/METAL SLEEVE	N/A	N/A
	NUT	N/A	N/A
	WASHER	N/A	N/A
095	TERMINAL	HOT SOLDER DIP	0.000100"MIN. HOT SOLDER DIP USING Sn60 PER IPC-J-STD-006 OVER 0.000100"MIN. COPPER PER SAE-AMS-2418
	BASE/METAL SLEEVE	N/A	N/A
	NUT	N/A	N/A
	WASHER	N/A	N/A

INSULATION COLOR OPTIONS:

1110-16M-XXXX

INSULATION COLOR	BLACK	BLUE	BROWN	GRAY	GREEN	ORANGE	RED	VIOLET	WHITE	YELLOW
COLOR CODE NO.	10	16	11	18	15	13	12	17	19	14

TOLERANCES:*

DECIMAL	FRACTIONAL	ANGULAR	DRAWING ORIENTATION DATE	LAST MODIFICATION DATE
± 0.015	N/A	± 3 °	9/6/1996	3/1/2017

*All dimensions are in inches.

RoHS COMPLIANCE:

1110-16M-05XX

PART NUMBER	RoHS COMPLIANT
1110-16M-0510	NO
1110-16M-0511	NO
1110-16M-0512	NO
1110-16M-0513	NO
1110-16M-0514	NO
1110-16M-0515	NO
1110-16M-0516	NO
1110-16M-0517	NO
1110-16M-0518	NO
1110-16M-0519	NO

1110-16M-088XX

PART NUMBER	RoHS COMPLIANT
1110-16M-08810	NO
1110-16M-08811	NO
1110-16M-08812	NO
1110-16M-08813	NO
1110-16M-08814	NO
1110-16M-08815	NO
1110-16M-08816	NO
1110-16M-08817	NO
1110-16M-08818	NO
1110-16M-08819	NO

1110-16M-095XX

PART NUMBER	RoHS COMPLIANT
1110-16M-09510	NO
1110-16M-09511	NO
1110-16M-09512	NO
1110-16M-09513	NO
1110-16M-09514	NO
1110-16M-09515	NO
1110-16M-09516	NO
1110-16M-09517	NO
1110-16M-09518	NO
1110-16M-09519	NO

MILITARY REFERENCE SPECIFICATIONS:

1110-16M-05XX

PART NUMBER	MIL SPECIFICATION	MIL PART NUMBER	COMMERCIAL ITEM DESCRIPTION (CID) SPECIFICATION	CID PART NUMBER
1110-16M-0510	MIL-T-55155/03	M55155/030H01 (FT030B01S)	A-A-59126/03	AA59126/030H01
1110-16M-0511	MIL-T-55155/03	M55155/031H01 (FT031B01S)	A-A-59126/03	AA59126/031H01
1110-16M-0512	MIL-T-55155/03	M55155/032H01 (FT032B01S)	A-A-59126/03	AA59126/032H01
1110-16M-0513	MIL-T-55155/03	M55155/033H01 (FT033B01S)	A-A-59126/03	AA59126/033H01
1110-16M-0514	MIL-T-55155/03	M55155/034H01 (FT034B01S)	A-A-59126/03	AA59126/034H01
1110-16M-0515	MIL-T-55155/03	M55155/035H01 (FT035B01S)	A-A-59126/03	AA59126/035H01
1110-16M-0516	MIL-T-55155/03	M55155/036H01 (FT036B01S)	A-A-59126/03	AA59126/036H01
1110-16M-0517	MIL-T-55155/03	M55155/037H01 (FT037B01S)	A-A-59126/03	AA59126/037H01
1110-16M-0518	MIL-T-55155/03	M55155/038H01 (FT038B01S)	A-A-59126/03	AA59126/038H01
1110-16M-0519	MIL-T-55155/03	M55155/039H01 (FT039B01S)	A-A-59126/03	AA59126/039H01

1110-16M-088XX

PART NUMBER	MIL SPECIFICATION	MIL PART NUMBER	COMMERCIAL ITEM DESCRIPTION (CID) SPECIFICATION	CID PART NUMBER
1110-16M-08810	MIL-T-55155/03	M55155/030J01	A-A-59126/03	AA59126/030J01 (AA59126/03001)
1110-16M-08811	MIL-T-55155/03	M55155/031J01	A-A-59126/03	AA59126/031J01 (AA59126/03101)
1110-16M-08812	MIL-T-55155/03	M55155/032J01	A-A-59126/03	AA59126/032J01 (AA59126/03201)
1110-16M-08813	MIL-T-55155/03	M55155/033J01	A-A-59126/03	AA59126/033J01 (AA59126/03301)
1110-16M-08814	MIL-T-55155/03	M55155/034J01	A-A-59126/03	AA59126/034J01 (AA59126/03401)

Continued on next page...

MILITARY REFERENCE SPECIFICATIONS CONTINUED:

1110-16M-088XX

PART NUMBER	MIL SPECIFICATION	MIL PART NUMBER	COMMERCIAL ITEM DESCRIPTION (CID) SPECIFICATION	CID PART NUMBER
1110-16M-08815	MIL-T-55155/03	M55155/035J01	A-A-59126/03	AA59126/035J01 (AA59126/03501)
1110-16M-08816	MIL-T-55155/03	M55155/036J01	A-A-59126/03	AA59126/036J01 (AA59126/03601)
1110-16M-08817	MIL-T-55155/03	M55155/037J01	A-A-59126/03	AA59126/037J01 (AA59126/03701)
1110-16M-08818	MIL-T-55155/03	M55155/038J01	A-A-59126/03	AA59126/038J01 (AA59126/03801)
1110-16M-08819	MIL-T-55155/03	M55155/039J01	A-A-59126/03	AA59126/039J01 (AA59126/03901)

1110-16M-095XX

PART NUMBER	MIL SPECIFICATION	MIL PART NUMBER	COMMERCIAL ITEM DESCRIPTION (CID) SPECIFICATION	CID PART NUMBER
1110-16M-09510	MIL-T-55155/03	M55155/030I01	A-A-59126/03	AA59126/030I01
1110-16M-09511	MIL-T-55155/03	M55155/031I01	A-A-59126/03	AA59126/031I01
1110-16M-09512	MIL-T-55155/03	M55155/032I01	A-A-59126/03	AA59126/032I01
1110-16M-09513	MIL-T-55155/03	M55155/033I01	A-A-59126/03	AA59126/033I01
1110-16M-09514	MIL-T-55155/03	M55155/034I01	A-A-59126/03	AA59126/034I01
1110-16M-09515	MIL-T-55155/03	M55155/035I01	A-A-59126/03	AA59126/035I01
1110-16M-09516	MIL-T-55155/03	M55155/036I01	A-A-59126/03	AA59126/036I01
1110-16M-09517	MIL-T-55155/03	M55155/037I01	A-A-59126/03	AA59126/037I01
1110-16M-09518	MIL-T-55155/03	M55155/038I01	A-A-59126/03	AA59126/038I01
1110-16M-09519	MIL-T-55155/03	M55155/039I01	A-A-59126/03	AA59126/039I01

TOOLING:

INSTALLATION TOOL: ARBOR PRESS	INSTALLATION TOOL: ANVIL (ARBOR PRESS OPERATED)	INSTALLATION TOOL: PRESS-FIT / ROLL SWAGE / RIVET PUNCH (ARBOR PRESS OPERATED)	INSTALLATION TOOL: PRESS-FIT (HAND OPERATED)
TM1	TA1110-16	TPI1110-16	TTI1110-16

NOTES:

DATASHEET NOTES

N/A

INSTRUCTION NOTES

SEE GENERAL PRESS FIT INSTALLATION INSTRUCTION ON CONCORD ELECTRONICS' WEBSITE WWW.CONCORD-ELECTRONICS.COM.