

DRAWING NUMBER:	1175-402-XXXX
PRODUCT GROUP:	TERMINALS
SUB-GROUP:	COMMERCIAL INSULATED TERMINALS
DESCRIPTION:	PTFE INSULATED DOUBLE TURRET TERMINAL

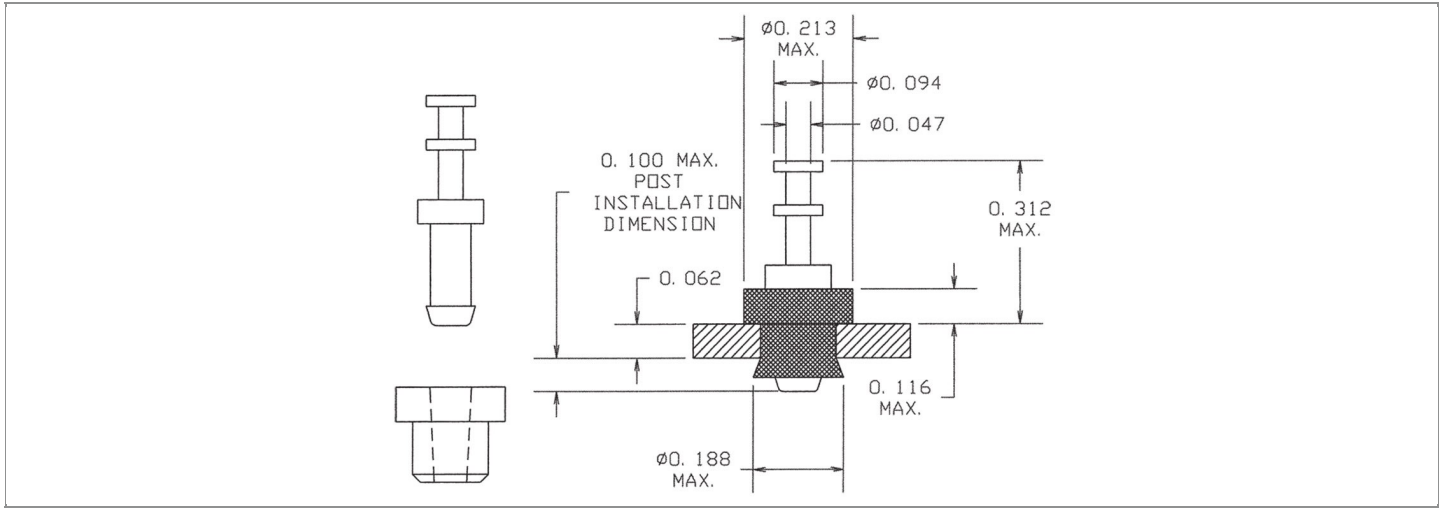

OVERALL LENGTH	PIN DIAMETER	FEED THRU COMBINATION	BOARD / PANEL MOUNTING METHOD
0.447" REF.	N/A	N/A	PRESS LOCK
SHANK LENGTH (L)	BOARD / PANEL THICKNESS	MOUNTING HOLE SIZE	DRILL SIZE
N/A	1/16"	0.142" (+0.003/-0.001)	#27

PART NO. STRUCTURE:

1175	-	402	-	XX	XX
PART SERIES		DIMENSION		FINISH	INSULATION COLOR

MATERIAL OPTIONS:

1175-402-XXXX

COMPONENT	MATERIAL	MATERIAL AND SPECIFICATION
TERMINAL	BRASS	BRASS PER ASTM B16, ALLOY C36000, 1/2 HARD
BASE/METAL SLEEVE	N/A	N/A
INSULATION*	PTFE	PTFE PER ASTM D1710
NUT	N/A	N/A
WASHER	N/A	N/A

*For Insulation color, please see INSULATION COLOR OPTIONS on Page 3

FINISH - PLATING OPTIONS:

1175-402-XXXX

FINISH CODE	COMPONENT	FINISH	FINISH AND SPECIFICATION
01	TERMINAL	SILVER	0.000300"MIN. SILVER PER ASTM B700, TYPE 2, GRADE D WITH A NON-CHROMATE PRESERVATIVE TREATMENT
	BASE/METAL SLEEVE	N/A	N/A
	NUT	N/A	N/A
	WASHER	N/A	N/A
03	TERMINAL	GOLD	0.00010"MIN. GOLD PER ASTM B488, TYPE II, CODE C OVER 0.000100"MIN. NICKEL PER SAE-AMS-QQ-N-290
	BASE/METAL SLEEVE	N/A	N/A
	NUT	N/A	N/A
	WASHER	N/A	N/A
04	TERMINAL	ELECTRO-TIN	0.000300"MIN. ELECTRO-TIN PER ASTM B545 OVER 0.000100"MIN. NICKEL PER SAE-AMS-QQ-N-290
	BASE/METAL SLEEVE	N/A	N/A
	NUT	N/A	N/A
	WASHER	N/A	N/A
044	TERMINAL	BRIGHT ELECTRO-TIN	0.000300"MIN. BRIGHT ELECTRO-TIN PER ASTM B545 OVER 0.000100"MIN. NICKEL PER SAE-AMS-QQ-N-290
	BASE/METAL SLEEVE	N/A	N/A
	NUT	N/A	N/A
	WASHER	N/A	N/A
05	TERMINAL	ELECTRO-SOLDER	0.000300"MIN. ELECTRO-SOLDER PER SAE-AMS-P-81728 OVER 0.000100"MIN. NICKEL PER SAE-AMS-QQ-N-290
	BASE/METAL SLEEVE	N/A	N/A
	NUT	N/A	N/A
	WASHER	N/A	N/A
088	TERMINAL	BRIGHT TIN-LEAD	0.000300"MIN. BRIGHT TIN-LEAD (Sn93%-Pb7%) PER ASTM B545 OVER 0.000100"MIN. NICKEL PER SAE-AMS-QQ-N-290
	BASE/METAL SLEEVE	N/A	N/A
	NUT	N/A	N/A
	WASHER	N/A	N/A

INSULATION COLOR OPTIONS:

1175-402-XX **XX**

INSULATION COLOR	BLACK	BLUE	BROWN	GRAY	GREEN	ORANGE	RED	VIOLET	WHITE	YELLOW
COLOR CODE NO.	10	16	11	18	15	13	12	17	19	14

TOLERANCES:*

DECIMAL	FRACTIONAL	ANGULAR	DRAWING ORIGATION DATE	LAST MODIFICATION DATE
± 0.005	± 1/64	± 5 °	12/5/2000	3/1/2017

*All dimensions are in inches.

RoHS COMPLIANCE:

1175-402-01XX

PART NUMBER	RoHS COMPLIANT
1175-402-0110	YES
1175-402-0111	NO
1175-402-0112	NO
1175-402-0113	NO
1175-402-0114	NO
1175-402-0115	YES
1175-402-0116	YES
1175-402-0117	YES
1175-402-0118	NO
1175-402-0119	YES

1175-402-03XX

PART NUMBER	RoHS COMPLIANT
1175-402-0310	YES
1175-402-0311	NO
1175-402-0312	NO
1175-402-0313	NO
1175-402-0314	NO
1175-402-0315	YES
1175-402-0316	YES
1175-402-0317	YES
1175-402-0318	NO
1175-402-0319	YES

1175-402-04XX

PART NUMBER	RoHS COMPLIANT
1175-402-0410	YES
1175-402-0411	NO
1175-402-0412	NO
1175-402-0413	NO
1175-402-0414	NO
1175-402-0415	YES
1175-402-0416	YES
1175-402-0417	YES
1175-402-0418	NO
1175-402-0419	YES

1175-402-044XX

PART NUMBER	RoHS COMPLIANT
1175-402-04410	YES
1175-402-04411	NO
1175-402-04412	NO
1175-402-04413	NO
1175-402-04414	NO
1175-402-04415	YES
1175-402-04416	YES
1175-402-04417	YES
1175-402-04418	NO
1175-402-04419	YES

1175-402-05XX

PART NUMBER	RoHS COMPLIANT
1175-402-0510	NO
1175-402-0511	NO
1175-402-0512	NO
1175-402-0513	NO
1175-402-0514	NO
1175-402-0515	NO
1175-402-0516	NO
1175-402-0517	NO
1175-402-0518	NO
1175-402-0519	NO

1175-402-088XX

PART NUMBER	RoHS COMPLIANT
1175-402-08810	NO
1175-402-08811	NO
1175-402-08812	NO
1175-402-08813	NO
1175-402-08814	NO
1175-402-08815	NO
1175-402-08816	NO
1175-402-08817	NO
1175-402-08818	NO
1175-402-08819	NO

TOOLING:

INSTALLATION TOOL: ARBOR PRESS	INSTALLATION TOOL: ANVIL (ARBOR PRESS OPERATED)	INSTALLATION TOOL: PRESS-FIT / ROLL SWAGE / RIVET PUNCH (ARBOR PRESS OPERATED)	INSTALLATION TOOL: PRESS-FIT (HAND OPERATED)
TM1	TA1175-402	TPI1175-402	N/A

NOTES:

DATASHEET NOTES

PIN TERMINAL AND BUSHING (INSULATION) SUPPLIED UNASSEMBLED.

INSTRUCTION NOTES

THIS PTFE INSULATED TERMINAL PROVIDES AN EXTRA SECURE MOUNTING ONTO THE BOARD OR CHASSIS. TO INSTALL, FIRST THE BUSHING IS INSERTED INTO THE MOUNTING HOLE. THE TERMINAL IS THEN PRESSED INTO THE BUSHING TO THE DRAWING DIMENSIONS. THE DIAMETER OF THE PTFE BUSHING THAT EXTENDS PAST THE BACK SIDE OF THE BOARD EXPANDS TO ANCHOR THE PIN/BUSHING ASSEMBLY IN PLACE. SEE GENERAL PRESS LOCK INSTALLATION INSTRUCTION ON CONCORD ELECTRONICS' WEBSITE WWW.CONCORD-ELECTRONICS.COM.