

<b>DRAWING NUMBER:</b>	<b>1169-92-XXXX</b>
<b>PRODUCT GROUP:</b>	TERMINALS
<b>SUB-GROUP:</b>	COMMERCIAL INSULATED TERMINALS
<b>DESCRIPTION:</b>	DIALLYL PHTHALATE INSULATED TERMINAL WITH THREADED TOP

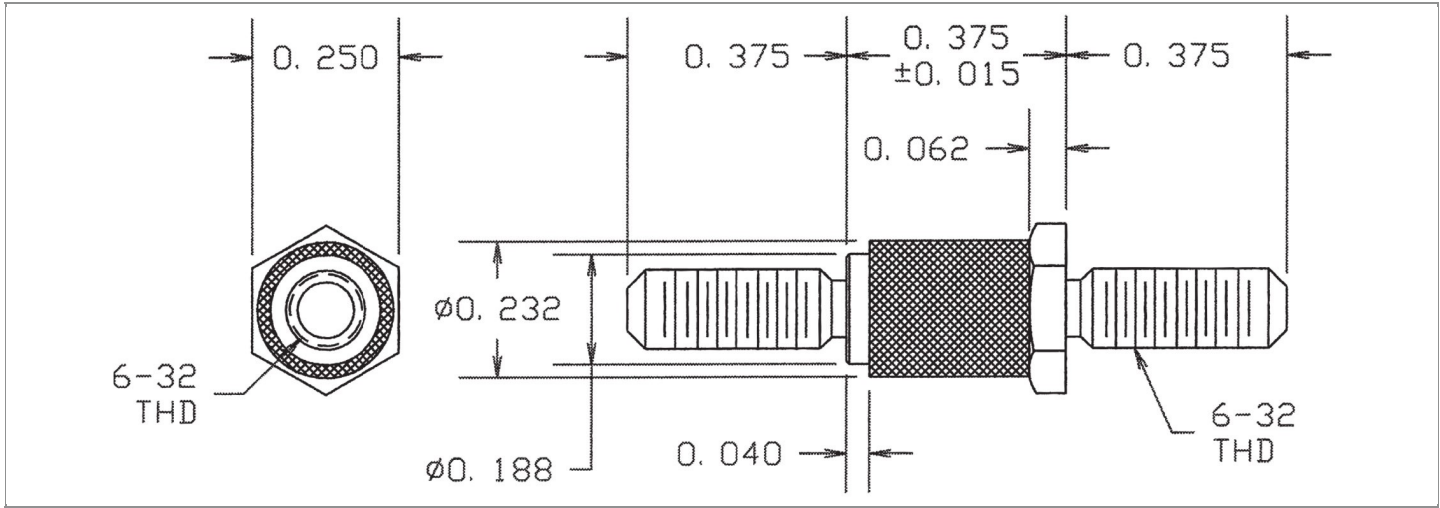

OVERALL LENGTH	PIN DIAMETER	FEED THRU COMBINATION	BOARD / PANEL MOUNTING METHOD
1.125"	N/A	N/A	THREAD MOUNT (6-32 NUT)
SHANK LENGTH (L)	BOARD / PANEL THICKNESS	MOUNTING HOLE SIZE	DRILL SIZE
N/A	UP TO 1/4"	0.144" ± 0.002	#27

**PART NO. STRUCTURE:**

<b>1169</b>	-	<b>92</b>	-	<b>XX</b>	<b>XX</b>
PART SERIES		DIMENSION		FINISH	INSULATION COLOR

**MATERIAL OPTIONS:**

**1169-92-XXXX**

COMPONENT	MATERIAL	MATERIAL AND SPECIFICATION
TERMINAL	BRASS	BRASS PER ASTM B16, ALLOY C36000, 1/2 HARD
BASE/METAL SLEEVE	BRASS	BRASS PER ASTM B16, ALLOY C36000, 1/2 HARD
INSULATION*	DIALLYL PHTHALATE	MOLDED DIALLYL PHTHALATE, TYPE SDG-F PER ASTM D5948
NUT	N/A	N/A
WASHER	N/A	N/A

\*For Insulation color, please see INSULATION COLOR OPTIONS on Page 2

FINISH - PLATING OPTIONS:

1169-92-XXXX

FINISH CODE	COMPONENT	FINISH	FINISH AND SPECIFICATION
075	TERMINAL	ZINC	0.000100"MIN. ZINC WITH YELLOW TRIVALENT CHROMATE PER ASTM B633
	BASE/METAL SLEEVE	ZINC	0.000100"MIN. ZINC WITH YELLOW TRIVALENT CHROMATE PER ASTM B633
	NUT	N/A	N/A
	WASHER	N/A	N/A

INSULATION COLOR OPTIONS:

1169-92-XXXX

INSULATION COLOR	BLACK	BLUE	BROWN	GRAY	GREEN	ORANGE	RED	VIOLET	WHITE	YELLOW
COLOR CODE NO.	10	16	11	18	15	13	12	17	19	14

TOLERANCES:\*

DECIMAL	FRACTIONAL	ANGULAR	DRAWING ORIGATION DATE	LAST MODIFICATION DATE
± 0.005	± 1/64	± 5 °	2/25/2002	3/1/2017

\*All dimensions are in inches.

RoHS COMPLIANCE:

1169-92-075XX

PART NUMBER	RoHS COMPLIANT
1169-92-07510	YES
1169-92-07511	YES
1169-92-07512	YES
1169-92-07513	YES
1169-92-07514	YES
1169-92-07515	YES
1169-92-07516	YES
1169-92-07517	YES
1169-92-07518	YES
1169-92-07519	YES

TOOLING:

INSTALLATION TOOL: ARBOR PRESS	INSTALLATION TOOL: ANVIL (ARBOR PRESS OPERATED)	INSTALLATION TOOL: PRESS-FIT / ROLL SWAGE / RIVET PUNCH (ARBOR PRESS OPERATED)	INSTALLATION TOOL: PRESS-FIT (HAND OPERATED)
N/A	N/A	N/A	N/A

**NOTES:**

---

**DATASHEET NOTES**

MATERIAL AND FINISH FOR THREADED HEX BASE AND TOP MOUNTS ARE THE SAME. NUT AND WASHER ARE NOT INCLUDED.

---

**INSTRUCTION NOTES**

N/A

---