

<b>DRAWING NUMBER:</b>	<b>1126-41-XXXX</b>
<b>PRODUCT GROUP:</b>	TERMINALS
<b>SUB-GROUP:</b>	COMMERCIAL INSULATED TERMINALS
<b>DESCRIPTION:</b>	PTFE INSULATED TURRET TERMINAL

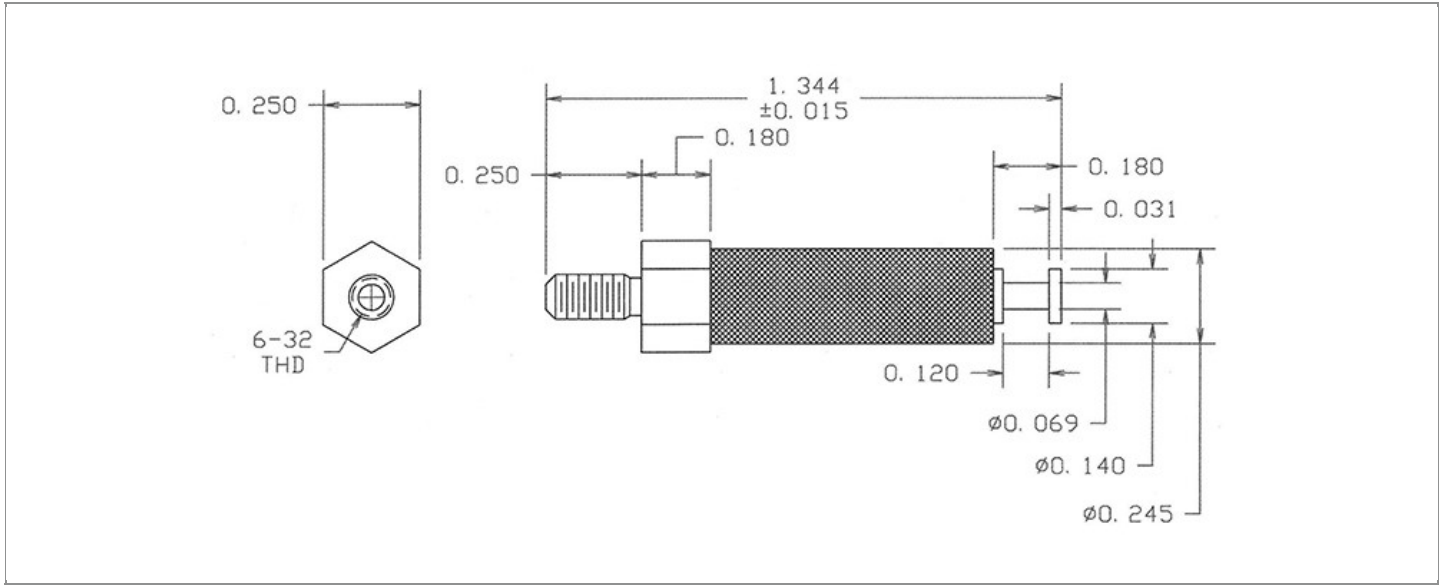

OVERALL LENGTH	PIN DIAMETER	FEED THRU COMBINATION	BOARD / PANEL MOUNTING METHOD
1.344"	N/A	N/A	THREAD MOUNT (6-32 NUT)
SHANK LENGTH (L)	BOARD / PANEL THICKNESS	MOUNTING HOLE SIZE	DRILL SIZE
N/A	UP TO 1/8"	0.144" ± 0.002	#27

**PART NO. STRUCTURE:**

<b>1126</b>	-	<b>41</b>	-	<b>XX</b>	<b>XX</b>
PART SERIES		DIMENSION		FINISH	INSULATION COLOR

**MATERIAL OPTIONS:**

**1126-41-XXXX**

COMPONENT	MATERIAL	MATERIAL AND SPECIFICATION
TERMINAL	BRASS	BRASS PER ASTM B16, ALLOY C36000, 1/2 HARD
BASE/METAL SLEEVE	BRASS	BRASS PER ASTM B16, ALLOY C36000, 1/2 HARD
INSULATION*	PTFE	PTFE PER ASTM D1710
NUT	N/A	N/A
WASHER	N/A	N/A

\*For Insulation color, please see INSULATION COLOR OPTIONS on Page 3

## FINISH - PLATING OPTIONS:

1126-41-XXXX

FINISH CODE	COMPONENT	FINISH	FINISH AND SPECIFICATION
01	TERMINAL	SILVER	0.000300"MIN. SILVER PER ASTM B700, TYPE 2, GRADE D WITH A NON-CHROMATE PRESERVATIVE TREATMENT
	BASE/METAL SLEEVE	ZINC	0.000100"MIN. ZINC WITH YELLOW TRIVALENT CHROMATE PER ASTM B633
	NUT	N/A	N/A
	WASHER	N/A	N/A
03	TERMINAL	GOLD	0.000010"MIN. GOLD PER ASTM B488, TYPE II, CODE C OVER 0.000100"MIN. NICKEL PER SAE-AMS-QQ-N-290
	BASE/METAL SLEEVE	ZINC	0.000100"MIN. ZINC WITH YELLOW TRIVALENT CHROMATE PER ASTM B633
	NUT	N/A	N/A
	WASHER	N/A	N/A
04	TERMINAL	ELECTRO-TIN	0.000300"MIN. ELECTRO-TIN PER ASTM B545 OVER 0.000100"MIN. NICKEL PER SAE-AMS-QQ-N-290
	BASE/METAL SLEEVE	ZINC	0.000100"MIN. ZINC WITH YELLOW TRIVALENT CHROMATE PER ASTM B633
	NUT	N/A	N/A
	WASHER	N/A	N/A
044	TERMINAL	BRIGHT ELECTRO-TIN	0.000300"MIN. BRIGHT ELECTRO-TIN PER ASTM B545 OVER 0.000100"MIN. NICKEL PER SAE-AMS-QQ-N-290
	BASE/METAL SLEEVE	ZINC	0.000100"MIN. ZINC WITH YELLOW TRIVALENT CHROMATE PER ASTM B633
	NUT	N/A	N/A
	WASHER	N/A	N/A
05	TERMINAL	ELECTRO-SOLDER	0.000300"MIN. ELECTRO-SOLDER PER SAE-AMS-P-81728 OVER 0.000100"MIN. NICKEL PER SAE-AMS-QQ-N-290
	BASE/METAL SLEEVE	ZINC	0.000100"MIN. ZINC WITH YELLOW TRIVALENT CHROMATE PER ASTM B633
	NUT	N/A	N/A
	WASHER	N/A	N/A
088	TERMINAL	BRIGHT TIN-LEAD	0.000300"MIN. BRIGHT TIN-LEAD (Sn93%-Pb7%) PER ASTM B545 OVER 0.000100"MIN. NICKEL PER SAE-AMS-QQ-N-290
	BASE/METAL SLEEVE	ZINC	0.000100"MIN. ZINC WITH YELLOW TRIVALENT CHROMATE PER ASTM B633
	NUT	N/A	N/A
	WASHER	N/A	N/A

INSULATION COLOR OPTIONS:

1126-41-XX **XX**

INSULATION COLOR	BLACK	BLUE	BROWN	GRAY	GREEN	ORANGE	RED	VIOLET	WHITE	YELLOW
COLOR CODE NO.	10	16	11	18	15	13	12	17	19	14

TOLERANCES:\*

DECIMAL	FRACTIONAL	ANGULAR	DRAWING ORIGATION DATE	LAST MODIFICATION DATE
± 0.005	± 1/64	± 5 °	7/5/2001	3/1/2017

\*All dimensions are in inches.

RoHS COMPLIANCE:

1126-41-01XX

PART NUMBER	RoHS COMPLIANT
1126-41-0110	YES
1126-41-0111	NO
1126-41-0112	NO
1126-41-0113	NO
1126-41-0114	NO
1126-41-0115	YES
1126-41-0116	YES
1126-41-0117	YES
1126-41-0118	NO
1126-41-0119	YES

1126-41-03XX

PART NUMBER	RoHS COMPLIANT
1126-41-0310	YES
1126-41-0311	NO
1126-41-0312	NO
1126-41-0313	NO
1126-41-0314	NO
1126-41-0315	YES
1126-41-0316	YES
1126-41-0317	YES
1126-41-0318	NO
1126-41-0319	YES

1126-41-04XX

PART NUMBER	RoHS COMPLIANT
1126-41-0410	YES
1126-41-0411	NO
1126-41-0412	NO
1126-41-0413	NO
1126-41-0414	NO
1126-41-0415	YES
1126-41-0416	YES
1126-41-0417	YES
1126-41-0418	NO
1126-41-0419	YES

1126-41-044XX

PART NUMBER	RoHS COMPLIANT
1126-41-04410	YES
1126-41-04411	NO
1126-41-04412	NO
1126-41-04413	NO
1126-41-04414	NO
1126-41-04415	YES
1126-41-04416	YES
1126-41-04417	YES
1126-41-04418	NO
1126-41-04419	YES

1126-41-05XX

PART NUMBER	RoHS COMPLIANT
1126-41-0510	NO
1126-41-0511	NO
1126-41-0512	NO
1126-41-0513	NO
1126-41-0514	NO
1126-41-0515	NO
1126-41-0516	NO
1126-41-0517	NO
1126-41-0518	NO
1126-41-0519	NO

1126-41-088XX

PART NUMBER	RoHS COMPLIANT
1126-41-08810	NO
1126-41-08811	NO
1126-41-08812	NO
1126-41-08813	NO
1126-41-08814	NO
1126-41-08815	NO
1126-41-08816	NO
1126-41-08817	NO
1126-41-08818	NO
1126-41-08819	NO

TOOLING:

INSTALLATION TOOL: ARBOR PRESS	INSTALLATION TOOL: ANVIL (ARBOR PRESS OPERATED)	INSTALLATION TOOL: PRESS-FIT / ROLL SWAGE / RIVET PUNCH (ARBOR PRESS OPERATED)	INSTALLATION TOOL: PRESS-FIT (HAND OPERATED)
N/A	N/A	N/A	N/A

NOTES:

**DATASHEET NOTES**

NUT AND WASHER ARE NOT INCLUDED.

**INSTRUCTION NOTES**

N/A