

DRAWING NUMBER:	09-9677-X-XX
PRODUCT GROUP:	PC JACKS
SUB-GROUP:	NON-INSULATED PC JACKS
DESCRIPTION:	PC JACK - NON-INSULATED - FEED THRU

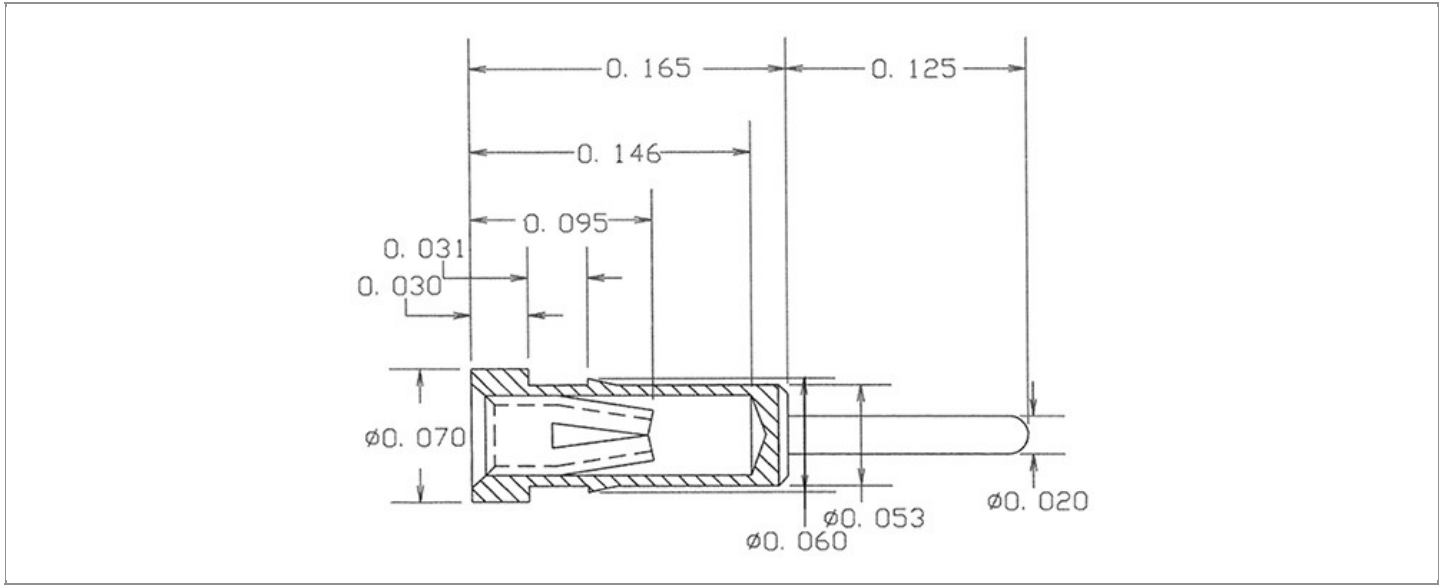

ACCEPTS PIN / PLUG / JACK SIZE	MOUNTING ORIENTATION	BOARD / PANEL MOUNTING METHOD	MOUNTING HOLE SIZE	DRILL SIZE	FEED THRU COMBINATION
0.015" - 0.025"	VERTICAL	PRESS FIT/SOLDER	0.057" ± 0.001	#54	JACK/PIN

PART NO. STRUCTURE:

09-9677	-	1	-	XX
PART SERIES		DIMENSION		FINISH

MATERIAL OPTIONS:

09-9677-1-XX

COMPONENT	MATERIAL	MATERIAL AND SPECIFICATION
BODY	BRASS	BRASS PER ASTM B16, ALLOY C36000, 1/2 HARD
SPRING (CAGE)	BERYLLIUM COPPER	BERYLLIUM COPPER PER ASTM B194, ALLOY C17200
MOUNTING BRACKET	N/A	N/A

DIMENSION OPTIONS:

09-9677-1-XX

DIMENSION	A	H	OVERALL LENGTH	MIN. HOLE DEPTH	SHANK LENGTH (L)	BOARD/PANEL THICKNESS
1	N/A	N/A	0.290"	0.146"	N/A	1/16" - 3/32"

FINISH - PLATING OPTIONS:

09-9677-1-XX

FINISH CODE	COMPONENT	FINISH	FINISH AND SPECIFICATION
03	BODY	GOLD	0.000010"MIN. GOLD PER ASTM B488, TYPE II, CODE C OVER 0.000100"MIN. NICKEL PER SAE-AMS-QQ-N-290, CLASS 2
	SPRING (CAGE)	GOLD	0.000030"MIN. GOLD PER ASTM B488, TYPE II, CODE C OVER 0.000100"MIN. NICKEL PER SAE-AMS-QQ-N-290, CLASS 2
	MOUNTING BRACKET	N/A	N/A
035	BODY	GOLD	0.000020"MIN. GOLD PER ASTM B488, TYPE II, CODE C OVER 0.000100"MIN. NICKEL PER SAE-AMS-QQ-N-290, CLASS 2
	SPRING (CAGE)	GOLD	0.000050"MIN. GOLD PER ASTM B488, TYPE II, CODE C OVER 0.000100"MIN. NICKEL PER SAE-AMS-QQ-N-290, CLASS 2
	MOUNTING BRACKET	N/A	N/A
04	BODY	ELECTRO-TIN	0.000100"MIN. ELECTRO-TIN PER ASTM B545 OVER 0.000100"MIN. NICKEL PER SAE-AMS-QQ-N-290, CLASS 2
	SPRING (CAGE)	BRIGHT ELECTRO-TIN	0.000200"MIN. BRIGHT ELECTRO-TIN PER ASTM B545 OVER 0.000050"MIN. NICKEL PER SAE-AMS-QQ-N-290, CLASS 2
	MOUNTING BRACKET	N/A	N/A
06	BODY	ELECTRO-TIN	0.000100"MIN. ELECTRO-TIN PER ASTM B545 OVER 0.000100"MIN. NICKEL PER SAE-AMS-QQ-N-290, CLASS 2
	SPRING (CAGE)	GOLD	0.000030"MIN. GOLD PER ASTM B488, TYPE II, CODE C OVER 0.000100"MIN. NICKEL PER SAE-AMS-QQ-N-290, CLASS 2
	MOUNTING BRACKET	N/A	N/A
063	BODY	BRIGHT TIN-LEAD	0.000200"MIN. BRIGHT TIN-LEAD (Sn93%-Pb7%) PER ASTM B545 OVER 0.000100"MIN. NICKEL PER SAE-AMS-QQ-N-290, CLASS 2
	SPRING (CAGE)	GOLD	0.000030"MIN. GOLD PER ASTM B488, TYPE II, CODE C OVER 0.000100"MIN. NICKEL PER SAE-AMS-QQ-N-290, CLASS 2
	MOUNTING BRACKET	N/A	N/A
088	BODY	BRIGHT TIN-LEAD	0.000200"MIN. BRIGHT TIN-LEAD (Sn93%-Pb7%) PER ASTM B545 OVER 0.000100"MIN. NICKEL PER SAE-AMS-QQ-N-290, CLASS 2
	SPRING (CAGE)	BRIGHT TIN-LEAD	0.000200"MIN. BRIGHT TIN-LEAD (Sn93%-Pb7%) PER ASTM B545 OVER 0.000100"MIN. NICKEL PER SAE-AMS-QQ-N-290, CLASS 2
	MOUNTING BRACKET	N/A	N/A

TOLERANCES:*

DECIMAL	FRACTIONAL	ANGULAR	DRAWING ORIENTATION DATE	LAST MODIFICATION DATE
± 0.005	± 1/64	± 5 °	05/19/00	01/01/17

*All dimensions are in inches.

RoHS COMPLIANCE:

09-9677-1-XX

PART NUMBER	RoHS COMPLIANT
09-9677-1-03	YES
09-9677-1-035	YES
09-9677-1-04	YES
09-9677-1-06	YES
09-9677-1-063	NO
09-9677-1-088	NO

TOOLING:

INSTALLATION TOOL: ARBOR PRESS	INSTALLATION TOOL: ANVIL (ARBOR PRESS OPERATED)	INSTALLATION TOOL: PRESS-FIT / ROLL SWAGE / RIVET PUNCH (ARBOR PRESS OPERATED)	CRIMPING TOOL (COMMERCIAL VERSION)
TM1	TA09-9677	TPP09-9677	N/A

NOTES:

<p>DATASHEET NOTES</p> <p>THE MINIMUM PIN DIAMETER SHOULD BE NO MORE THAN 0.005" SMALLER THAN THE MAXIMUM PIN DIAMETER INSERTED.</p>
<p>INSTRUCTION NOTES</p> <p>SEE GENERAL PRESS FIT INSTALLATION INSTRUCTION ON CONCORD ELECTRONICS' WEBSITE WWW.CONCORD-ELECTRONICS.COM.</p>