

DRAWING NUMBER:	1110-36-XXXX
PRODUCT GROUP:	TERMINALS
SUB-GROUP:	COMMERCIAL INSULATED TERMINALS
DESCRIPTION:	PTFE INSULATED FEED THRU (PIN/PIN) TERMINAL

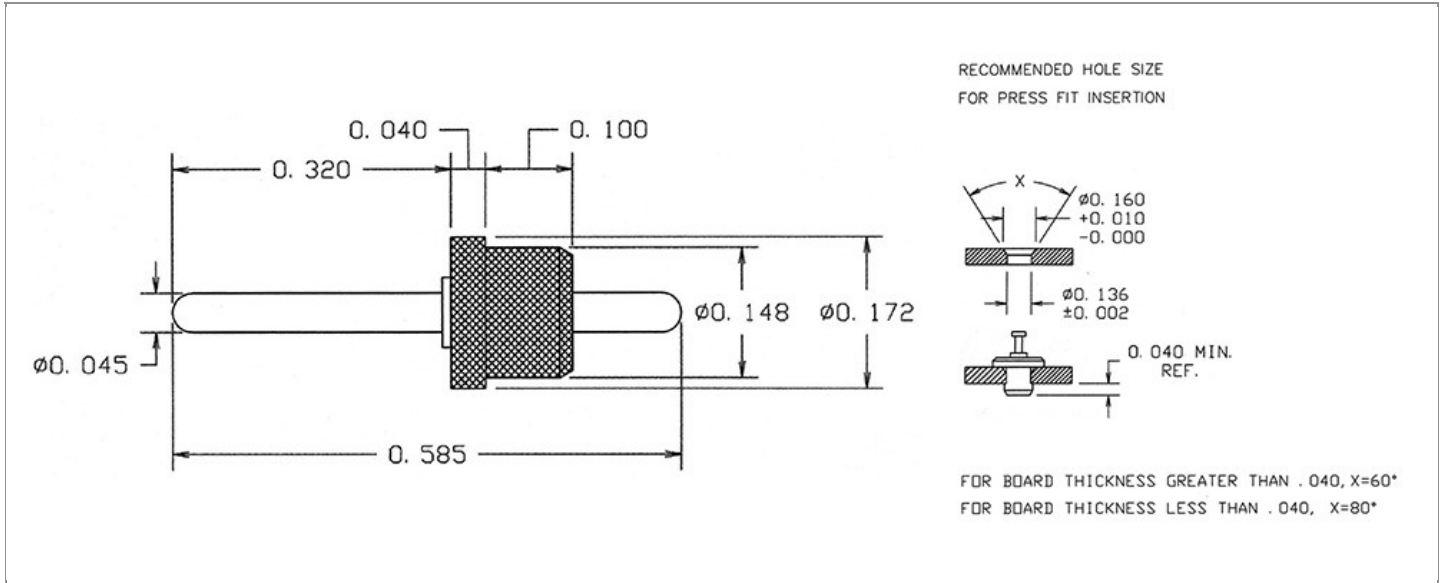

OVERALL LENGTH	PIN DIAMETER	FEED THRU COMBINATION	BOARD / PANEL MOUNTING METHOD
0.585"	0.045" ± 0.005	PIN/PIN	PRESS FIT
SHANK LENGTH (L)	BOARD / PANEL THICKNESS	MOUNTING HOLE SIZE	DRILL SIZE
N/A	UP TO 1/16"	0.136" ± 0.002	#29

PART NO. STRUCTURE:

1110	-	36	-	XX	XX
PART SERIES		DIMENSION		FINISH	INSULATION COLOR

MATERIAL OPTIONS:

1110-36-XXXX

COMPONENT	MATERIAL	MATERIAL AND SPECIFICATION
TERMINAL	BRASS	BRASS PER ASTM B16, ALLOY C36000, 1/2 HARD
BASE/METAL SLEEVE	N/A	N/A
INSULATION*	PTFE	PTFE PER ASTM D1710
NUT	N/A	N/A
WASHER	N/A	N/A

*For Insulation color, please see INSULATION COLOR OPTIONS on Page 3

FINISH - PLATING OPTIONS:

1110-36-XXXX

FINISH CODE	COMPONENT	FINISH	FINISH AND SPECIFICATION
01	TERMINAL	SILVER	0.000300"MIN. SILVER PER ASTM B700, TYPE 2, GRADE D WITH A NON-CHROMATE PRESERVATIVE TREATMENT
	BASE/METAL SLEEVE	N/A	N/A
	NUT	N/A	N/A
	WASHER	N/A	N/A
03	TERMINAL	GOLD	0.00010"MIN. GOLD PER ASTM B488, TYPE II, CODE C OVER 0.000100"MIN. NICKEL PER SAE-AMS-QQ-N-290
	BASE/METAL SLEEVE	N/A	N/A
	NUT	N/A	N/A
	WASHER	N/A	N/A
04	TERMINAL	ELECTRO-TIN	0.000300"MIN. ELECTRO-TIN PER ASTM B545 OVER 0.000100"MIN. NICKEL PER SAE-AMS-QQ-N-290
	BASE/METAL SLEEVE	N/A	N/A
	NUT	N/A	N/A
	WASHER	N/A	N/A
044	TERMINAL	BRIGHT ELECTRO-TIN	0.000300"MIN. BRIGHT ELECTRO-TIN PER ASTM B545 OVER 0.000100"MIN. NICKEL PER SAE-AMS-QQ-N-290
	BASE/METAL SLEEVE	N/A	N/A
	NUT	N/A	N/A
	WASHER	N/A	N/A
05	TERMINAL	ELECTRO-SOLDER	0.000300"MIN. ELECTRO-SOLDER PER SAE-AMS-P-81728 OVER 0.000100"MIN. NICKEL PER SAE-AMS-QQ-N-290
	BASE/METAL SLEEVE	N/A	N/A
	NUT	N/A	N/A
	WASHER	N/A	N/A
088	TERMINAL	BRIGHT TIN-LEAD	0.000300"MIN. BRIGHT TIN-LEAD (Sn93%-Pb7%) PER ASTM B545 OVER 0.000100"MIN. NICKEL PER SAE-AMS-QQ-N-290
	BASE/METAL SLEEVE	N/A	N/A
	NUT	N/A	N/A
	WASHER	N/A	N/A

INSULATION COLOR OPTIONS:

1110-36-XX **XX**

INSULATION COLOR	BLACK	BLUE	BROWN	GRAY	GREEN	ORANGE	RED	VIOLET	WHITE	YELLOW
COLOR CODE NO.	10	16	11	18	15	13	12	17	19	14

TOLERANCES:*

DECIMAL	FRACTIONAL	ANGULAR	DRAWING ORIGATION DATE	LAST MODIFICATION DATE
± 0.005	± 1/64	± 5 °	10/6/2000	3/1/2017

*All dimensions are in inches.

RoHS COMPLIANCE:

1110-36-01XX

PART NUMBER	RoHS COMPLIANT
1110-36-0110	YES
1110-36-0111	NO
1110-36-0112	NO
1110-36-0113	NO
1110-36-0114	NO
1110-36-0115	YES
1110-36-0116	YES
1110-36-0117	YES
1110-36-0118	NO
1110-36-0119	YES

1110-36-03XX

PART NUMBER	RoHS COMPLIANT
1110-36-0310	YES
1110-36-0311	NO
1110-36-0312	NO
1110-36-0313	NO
1110-36-0314	NO
1110-36-0315	YES
1110-36-0316	YES
1110-36-0317	YES
1110-36-0318	NO
1110-36-0319	YES

1110-36-04XX

PART NUMBER	RoHS COMPLIANT
1110-36-0410	YES
1110-36-0411	NO
1110-36-0412	NO
1110-36-0413	NO
1110-36-0414	NO
1110-36-0415	YES
1110-36-0416	YES
1110-36-0417	YES
1110-36-0418	NO
1110-36-0419	YES

1110-36-044XX

PART NUMBER	RoHS COMPLIANT
1110-36-04410	YES
1110-36-04411	NO
1110-36-04412	NO
1110-36-04413	NO
1110-36-04414	NO
1110-36-04415	YES
1110-36-04416	YES
1110-36-04417	YES
1110-36-04418	NO
1110-36-04419	YES

1110-36-05XX

PART NUMBER	RoHS COMPLIANT
1110-36-0510	NO
1110-36-0511	NO
1110-36-0512	NO
1110-36-0513	NO
1110-36-0514	NO
1110-36-0515	NO
1110-36-0516	NO
1110-36-0517	NO
1110-36-0518	NO
1110-36-0519	NO

1110-36-088XX

PART NUMBER	RoHS COMPLIANT
1110-36-08810	NO
1110-36-08811	NO
1110-36-08812	NO
1110-36-08813	NO
1110-36-08814	NO
1110-36-08815	NO
1110-36-08816	NO
1110-36-08817	NO
1110-36-08818	NO
1110-36-08819	NO

TOOLING:

INSTALLATION TOOL: ARBOR PRESS	INSTALLATION TOOL: ANVIL (ARBOR PRESS OPERATED)	INSTALLATION TOOL: PRESS-FIT / ROLL SWAGE / RIVET PUNCH (ARBOR PRESS OPERATED)	INSTALLATION TOOL: PRESS-FIT (HAND OPERATED)
TM1	TA1110-36	TPI1110-36	TTI1110-36

NOTES:

DATASHEET NOTES

N/A

INSTRUCTION NOTES

SEE GENERAL PRESS FIT INSTALLATION INSTRUCTION ON CONCORD ELECTRONICS' WEBSITE WWW.CONCORD-ELECTRONICS.COM.