

| | |
|------------------------|---|
| DRAWING NUMBER: | 1110-22-XXXX |
| PRODUCT GROUP: | TERMINALS |
| SUB-GROUP: | COMMERCIAL INSULATED TERMINALS |
| DESCRIPTION: | PTFE INSULATED FEED THRU (PIN/PIN) TERMINAL |

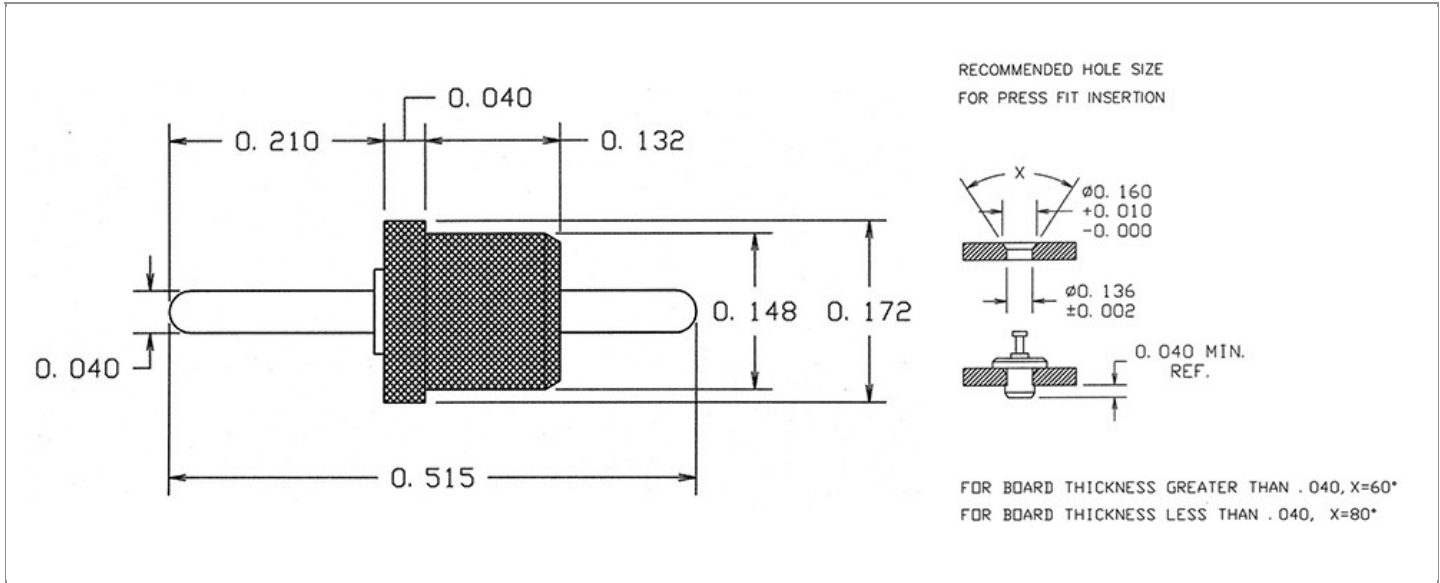

| OVERALL LENGTH | PIN DIAMETER | FEED THRU COMBINATION | BOARD / PANEL MOUNTING METHOD |
|----------------|----------------|-----------------------|-------------------------------|
| 0.515" | 0.040" ± 0.005 | PIN/PIN | PRESS FIT |

| SHANK LENGTH (L) | BOARD / PANEL THICKNESS | MOUNTING HOLE SIZE | DRILL SIZE |
|------------------|-------------------------|--------------------|------------|
| N/A | UP TO 3/32" | 0.136" ± 0.002 | #29 |

PART NO. STRUCTURE:

| | | | | | |
|-------------|---|-----------|---|--------|------------------|
| 1110 | - | 22 | - | XX | XX |
| PART SERIES | | DIMENSION | | FINISH | INSULATION COLOR |

MATERIAL OPTIONS:

1110-22-XXXX

| COMPONENT | MATERIAL | MATERIAL AND SPECIFICATION |
|-------------------|----------|--|
| TERMINAL | BRASS | BRASS PER ASTM B16, ALLOY C36000, 1/2 HARD |
| BASE/METAL SLEEVE | N/A | N/A |
| INSULATION* | PTFE | PTFE PER ASTM D1710 |
| NUT | N/A | N/A |
| WASHER | N/A | N/A |

*For Insulation color, please see INSULATION COLOR OPTIONS on Page 3

FINISH - PLATING OPTIONS:

1110-22-XXXX

| FINISH CODE | COMPONENT | FINISH | FINISH AND SPECIFICATION |
|-------------|-------------------|--------------------|---|
| 01 | TERMINAL | SILVER | 0.000300"MIN. SILVER PER ASTM B700, TYPE 2, GRADE D WITH A NON-CHROMATE PRESERVATIVE TREATMENT |
| | BASE/METAL SLEEVE | N/A | N/A |
| | NUT | N/A | N/A |
| | WASHER | N/A | N/A |
| 03 | TERMINAL | GOLD | 0.00010"MIN. GOLD PER ASTM B488, TYPE II, CODE C OVER 0.000100"MIN. NICKEL PER SAE-AMS-QQ-N-290 |
| | BASE/METAL SLEEVE | N/A | N/A |
| | NUT | N/A | N/A |
| | WASHER | N/A | N/A |
| 04 | TERMINAL | ELECTRO-TIN | 0.000300"MIN. ELECTRO-TIN PER ASTM B545 OVER 0.000100"MIN. NICKEL PER SAE-AMS-QQ-N-290 |
| | BASE/METAL SLEEVE | N/A | N/A |
| | NUT | N/A | N/A |
| | WASHER | N/A | N/A |
| 044 | TERMINAL | BRIGHT ELECTRO-TIN | 0.000300"MIN. BRIGHT ELECTRO-TIN PER ASTM B545 OVER 0.000100"MIN. NICKEL PER SAE-AMS-QQ-N-290 |
| | BASE/METAL SLEEVE | N/A | N/A |
| | NUT | N/A | N/A |
| | WASHER | N/A | N/A |
| 05 | TERMINAL | ELECTRO-SOLDER | 0.000300"MIN. ELECTRO-SOLDER PER SAE-AMS-P-81728 OVER 0.000100"MIN. NICKEL PER SAE-AMS-QQ-N-290 |
| | BASE/METAL SLEEVE | N/A | N/A |
| | NUT | N/A | N/A |
| | WASHER | N/A | N/A |
| 088 | TERMINAL | BRIGHT TIN-LEAD | 0.000300"MIN. BRIGHT TIN-LEAD (Sn93%-Pb7%) PER ASTM B545 OVER 0.000100"MIN. NICKEL PER SAE-AMS-QQ-N-290 |
| | BASE/METAL SLEEVE | N/A | N/A |
| | NUT | N/A | N/A |
| | WASHER | N/A | N/A |

INSULATION COLOR OPTIONS:

1110-22-XX **XX**

| INSULATION COLOR | BLACK | BLUE | BROWN | GRAY | GREEN | ORANGE | RED | VIOLET | WHITE | YELLOW |
|------------------|-------|------|-------|------|-------|--------|-----|--------|-------|--------|
| COLOR CODE NO. | 10 | 16 | 11 | 18 | 15 | 13 | 12 | 17 | 19 | 14 |

TOLERANCES:*

| DECIMAL | FRACTIONAL | ANGULAR | DRAWING ORIGATION DATE | LAST MODIFICATION DATE |
|---------|------------|---------|------------------------|------------------------|
| ± 0.005 | ± 1/64 | ± 5 ° | 10/6/2000 | 3/1/2017 |

*All dimensions are in inches.

RoHS COMPLIANCE:

1110-22-01XX

| PART NUMBER | RoHS COMPLIANT |
|--------------|----------------|
| 1110-22-0110 | YES |
| 1110-22-0111 | NO |
| 1110-22-0112 | NO |
| 1110-22-0113 | NO |
| 1110-22-0114 | NO |
| 1110-22-0115 | YES |
| 1110-22-0116 | YES |
| 1110-22-0117 | YES |
| 1110-22-0118 | NO |
| 1110-22-0119 | YES |

1110-22-03XX

| PART NUMBER | RoHS COMPLIANT |
|--------------|----------------|
| 1110-22-0310 | YES |
| 1110-22-0311 | NO |
| 1110-22-0312 | NO |
| 1110-22-0313 | NO |
| 1110-22-0314 | NO |
| 1110-22-0315 | YES |
| 1110-22-0316 | YES |
| 1110-22-0317 | YES |
| 1110-22-0318 | NO |
| 1110-22-0319 | YES |

1110-22-04XX

| PART NUMBER | RoHS COMPLIANT |
|--------------|----------------|
| 1110-22-0410 | YES |
| 1110-22-0411 | NO |
| 1110-22-0412 | NO |
| 1110-22-0413 | NO |
| 1110-22-0414 | NO |
| 1110-22-0415 | YES |
| 1110-22-0416 | YES |
| 1110-22-0417 | YES |
| 1110-22-0418 | NO |
| 1110-22-0419 | YES |

1110-22-044XX

| PART NUMBER | RoHS COMPLIANT |
|---------------|----------------|
| 1110-22-04410 | YES |
| 1110-22-04411 | NO |
| 1110-22-04412 | NO |
| 1110-22-04413 | NO |
| 1110-22-04414 | NO |
| 1110-22-04415 | YES |
| 1110-22-04416 | YES |
| 1110-22-04417 | YES |
| 1110-22-04418 | NO |
| 1110-22-04419 | YES |

1110-22-05XX

| PART NUMBER | RoHS COMPLIANT |
|--------------|----------------|
| 1110-22-0510 | NO |
| 1110-22-0511 | NO |
| 1110-22-0512 | NO |
| 1110-22-0513 | NO |
| 1110-22-0514 | NO |
| 1110-22-0515 | NO |
| 1110-22-0516 | NO |
| 1110-22-0517 | NO |
| 1110-22-0518 | NO |
| 1110-22-0519 | NO |

1110-22-088XX

| PART NUMBER | RoHS COMPLIANT |
|---------------|----------------|
| 1110-22-08810 | NO |
| 1110-22-08811 | NO |
| 1110-22-08812 | NO |
| 1110-22-08813 | NO |
| 1110-22-08814 | NO |
| 1110-22-08815 | NO |
| 1110-22-08816 | NO |
| 1110-22-08817 | NO |
| 1110-22-08818 | NO |
| 1110-22-08819 | NO |

TOOLING:

| INSTALLATION TOOL: ARBOR PRESS | INSTALLATION TOOL: ANVIL (ARBOR PRESS OPERATED) | INSTALLATION TOOL: PRESS-FIT / ROLL SWAGE / RIVET PUNCH (ARBOR PRESS OPERATED) | INSTALLATION TOOL: PRESS-FIT (HAND OPERATED) |
|-----------------------------------|---|--|--|
| TM1 | TA1110-22 | TPI1110-22 | TTI1110-22 |

NOTES:

| DATASHEET NOTES |
|-----------------|
|-----------------|

N/A

| INSTRUCTION NOTES |
|-------------------|
|-------------------|

SEE GENERAL PRESS FIT INSTALLATION INSTRUCTION ON CONCORD ELECTRONICS' WEBSITE WWW.CONCORD-ELECTRONICS.COM.