

DRAWING NUMBER:	1128-54-XXXX
PRODUCT GROUP:	PC JACKS
SUB-GROUP:	INSULATED PC JACKS
DESCRIPTION:	TEST POINT INSULATED JACK - HORIZONTAL MOUNT

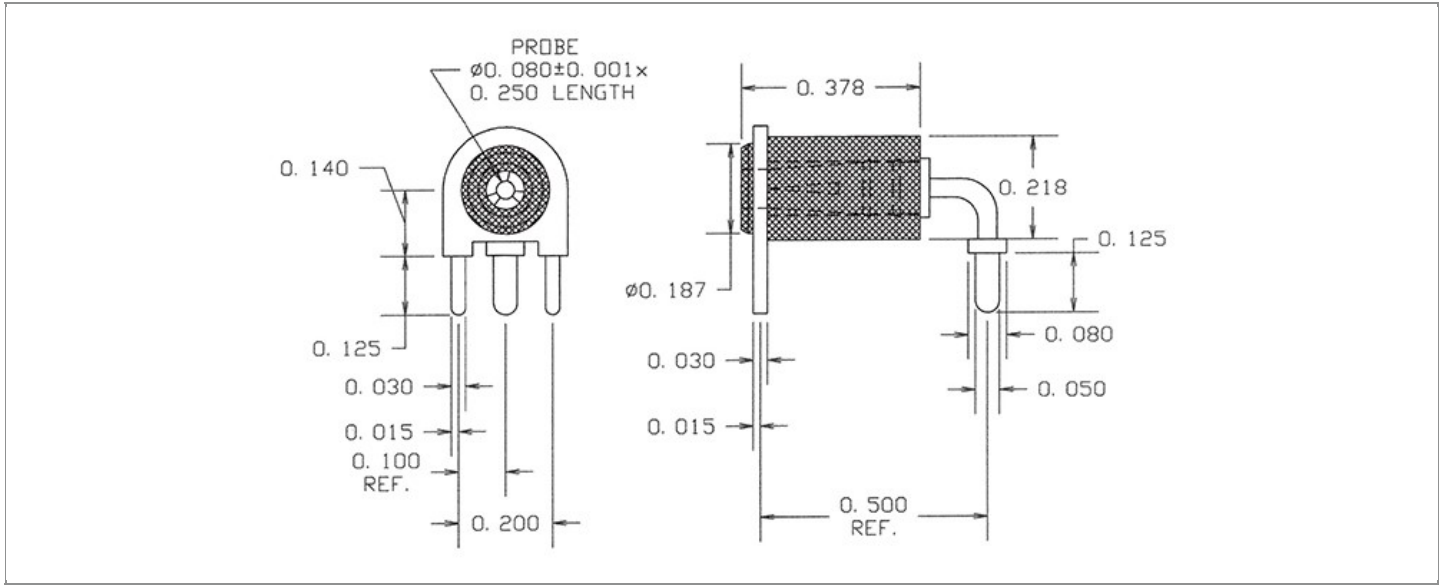

ACCEPTS PIN / PLUG / JACK SIZE	OVERALL LENGTH	MIN. HOLE DEPTH	MOUNTING ORIENTATION
0.080" ± 0.001	0.586"	0.250"	HORIZONTAL
BOARD / PANEL MOUNTING METHOD	MOUNTING HOLE SIZE	BOARD / PANEL THICKNESS	FEED THRU COMBINATION
SOLDER	0.062" ± 0.003	1/32" - 1/16"	N/A

PART NO. STRUCTURE:

1128	-	54	-	XX	XX
PART SERIES		DIMENSION		FINISH	INSULATION COLOR

MATERIAL OPTIONS:

1128-54-XXXX

COMPONENT	MATERIAL	MATERIAL AND SPECIFICATION
BODY	N/A	N/A
SPRING (CAGE)	BERYLLIUM COPPER	BERYLLIUM COPPER PER ASTM B196, ALLOY C17300
INSULATION*	PTFE	PTFE PER ASTM D1710
MOUNTING BRACKET	BRASS	BRASS PER ASTM B16, ALLOY C36000, 1/2 HARD

*For Insulation color, please see INSULATION COLOR OPTIONS on Page 2

FINISH - PLATING OPTIONS:

1128-54-XXXX

FINISH CODE	COMPONENT	FINISH	FINISH AND SPECIFICATION
03	BODY	N/A	N/A
	SPRING (CAGE)	GOLD	0.000010"MIN. GOLD PER ASTM B488, TYPE II, CODE C OVER 0.000100"MIN. NICKEL PER SAE-AMS-QQ-N-290, CLASS 2
	MOUNTING BRACKET	GOLD	0.000010"MIN. GOLD PER ASTM B488, TYPE II, CODE C OVER 0.000100"MIN. NICKEL PER SAE-AMS-QQ-N-290, CLASS 2
035	BODY	N/A	N/A
	SPRING (CAGE)	GOLD	0.000050"MIN. GOLD PER ASTM B488, TYPE II, CODE C OVER 0.000100"MIN. NICKEL PER SAE-AMS-QQ-N-290, CLASS 2
	MOUNTING BRACKET	GOLD	0.000020"MIN. GOLD PER ASTM B488, TYPE II, CODE C OVER 0.000100"MIN. NICKEL PER SAE-AMS-QQ-N-290, CLASS 2

INSULATION COLOR OPTIONS:

1128-54-XXXX

INSULATION COLOR	BLACK	BLUE	BROWN	GRAY	GREEN	ORANGE	RED	VIOLET	WHITE	YELLOW
COLOR CODE NO.	10	16	11	18	15	13	12	17	19	14

TOLERANCES:*

DECIMAL	FRACTIONAL	ANGULAR	DRAWING ORIGATION DATE	LAST MODIFICATION DATE
± 0.005	± 1/64	N/A	9/2/1998	1/1/2017

*All dimensions are in inches.

RoHS COMPLIANCE:

1128-54-03XX

PART NUMBER	RoHS COMPLIANT
1128-54-0310	YES
1128-54-0311	NO
1128-54-0312	NO
1128-54-0313	NO
1128-54-0314	NO
1128-54-0315	YES
1128-54-0316	YES
1128-54-0317	YES
1128-54-0318	NO
1128-54-0319	YES

1128-54-035XX

PART NUMBER	RoHS COMPLIANT
1128-54-03510	YES
1128-54-03511	NO
1128-54-03512	NO
1128-54-03513	NO
1128-54-03514	NO
1128-54-03515	YES
1128-54-03516	YES
1128-54-03517	YES
1128-54-03518	NO
1128-54-03519	YES

MILITARY REFERENCE SPECIFICATIONS:

1128-54-03XX

PART NUMBER	MIL SPECIFICATION	MIL PART NUMBER
1128-54-0310	N/A	N/A
1128-54-0311	N/A	N/A
1128-54-0312	N/A	N/A
1128-54-0313	N/A	N/A
1128-54-0314	N/A	N/A
1128-54-0315	N/A	N/A
1128-54-0316	N/A	N/A
1128-54-0317	N/A	N/A
1128-54-0318	N/A	N/A
1128-54-0319	N/A	N/A

1128-54-035XX

PART NUMBER	MIL SPECIFICATION	MIL PART NUMBER
1128-54-03510	N/A	N/A
1128-54-03511	N/A	N/A
1128-54-03512	N/A	N/A
1128-54-03513	N/A	N/A
1128-54-03514	N/A	N/A
1128-54-03515	N/A	N/A
1128-54-03516	N/A	N/A
1128-54-03517	N/A	N/A
1128-54-03518	N/A	N/A
1128-54-03519	N/A	N/A

TOOLING:

INSTALLATION TOOL: ARBOR PRESS	INSTALLATION TOOL: ANVIL (ARBOR PRESS OPERATED)	INSTALLATION TOOL: PRESS-FIT / ROLL SWAGE / RIVET PUNCH (ARBOR PRESS OPERATED)	INSTALLATION TOOL: PRESS-FIT (HAND OPERATED)	CRIMPING TOOL (COMMERCIAL VERSION)
N/A	N/A	N/A	N/A	N/A

NOTES:

DATASHEET NOTES

N/A

INSTRUCTION NOTES

N/A