

<b>DRAWING NUMBER:</b>	<b>1102-53-XXXX</b>
<b>PRODUCT GROUP:</b>	TERMINALS
<b>SUB-GROUP:</b>	COMMERCIAL INSULATED TERMINALS
<b>DESCRIPTION:</b>	PTFE INSULATED DOUBLE TURRET TERMINAL

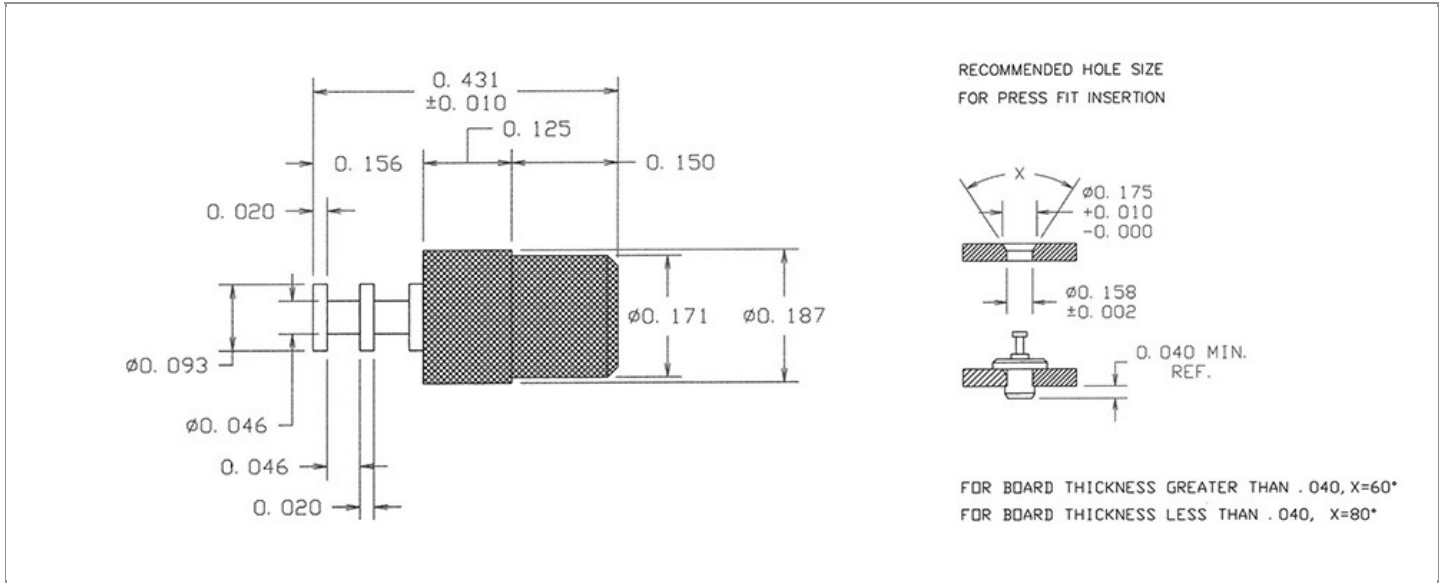

OVERALL LENGTH	PIN DIAMETER	FEED THRU COMBINATION	BOARD / PANEL MOUNTING METHOD
0.431"	N/A	N/A	PRESS FIT

SHANK LENGTH (L)	BOARD / PANEL THICKNESS	MOUNTING HOLE SIZE	DRILL SIZE
N/A	UP TO 1/8"	0.158" ± 0.002	#22

**PART NO. STRUCTURE:**

<b>1102</b>	-	<b>53</b>	-	<b>XX</b>	<b>XX</b>
PART SERIES		DIMENSION		FINISH	INSULATION COLOR

**MATERIAL OPTIONS:**

**1102-53-XXXX**

COMPONENT	MATERIAL	MATERIAL AND SPECIFICATION
TERMINAL	BRASS	BRASS PER ASTM B16, ALLOY C36000, 1/2 HARD
BASE/METAL SLEEVE	N/A	N/A
INSULATION*	PTFE	PTFE PER ASTM D1710
NUT	N/A	N/A
WASHER	N/A	N/A

\*For Insulation color, please see INSULATION COLOR OPTIONS on Page 3

## FINISH - PLATING OPTIONS:

1102-53-XXXX

FINISH CODE	COMPONENT	FINISH	FINISH AND SPECIFICATION
01	TERMINAL	SILVER	0.000300"MIN. SILVER PER ASTM B700, TYPE 2, GRADE D WITH A NON-CHROMATE PRESERVATIVE TREATMENT
	BASE/METAL SLEEVE	N/A	N/A
	NUT	N/A	N/A
	WASHER	N/A	N/A
03	TERMINAL	GOLD	0.00010"MIN. GOLD PER ASTM B488, TYPE II, CODE C OVER 0.000100"MIN. NICKEL PER SAE-AMS-QQ-N-290
	BASE/METAL SLEEVE	N/A	N/A
	NUT	N/A	N/A
	WASHER	N/A	N/A
04	TERMINAL	ELECTRO-TIN	0.000300"MIN. ELECTRO-TIN PER ASTM B545 OVER 0.000100"MIN. NICKEL PER SAE-AMS-QQ-N-290
	BASE/METAL SLEEVE	N/A	N/A
	NUT	N/A	N/A
	WASHER	N/A	N/A
044	TERMINAL	BRIGHT ELECTRO-TIN	0.000300"MIN. BRIGHT ELECTRO-TIN PER ASTM B545 OVER 0.000100"MIN. NICKEL PER SAE-AMS-QQ-N-290
	BASE/METAL SLEEVE	N/A	N/A
	NUT	N/A	N/A
	WASHER	N/A	N/A
05	TERMINAL	ELECTRO-SOLDER	0.000300"MIN. ELECTRO-SOLDER PER SAE-AMS-P-81728 OVER 0.000100"MIN. NICKEL PER SAE-AMS-QQ-N-290
	BASE/METAL SLEEVE	N/A	N/A
	NUT	N/A	N/A
	WASHER	N/A	N/A
088	TERMINAL	BRIGHT TIN-LEAD	0.000300"MIN. BRIGHT TIN-LEAD (Sn93%-Pb7%) PER ASTM B545 OVER 0.000100"MIN. NICKEL PER SAE-AMS-QQ-N-290
	BASE/METAL SLEEVE	N/A	N/A
	NUT	N/A	N/A
	WASHER	N/A	N/A

INSULATION COLOR OPTIONS:

1102-53-XX **XX**

INSULATION COLOR	BLACK	BLUE	BROWN	GRAY	GREEN	ORANGE	RED	VIOLET	WHITE	YELLOW
COLOR CODE NO.	10	16	11	18	15	13	12	17	19	14

TOLERANCES:\*

DECIMAL	FRACTIONAL	ANGULAR	DRAWING ORIGATION DATE	LAST MODIFICATION DATE
± 0.005	± 1/64	± 5 °	11/27/2002	3/1/2017

\*All dimensions are in inches.

RoHS COMPLIANCE:

1102-53-01XX

PART NUMBER	RoHS COMPLIANT
1102-53-0110	YES
1102-53-0111	NO
1102-53-0112	NO
1102-53-0113	NO
1102-53-0114	NO
1102-53-0115	YES
1102-53-0116	YES
1102-53-0117	YES
1102-53-0118	NO
1102-53-0119	YES

1102-53-03XX

PART NUMBER	RoHS COMPLIANT
1102-53-0310	YES
1102-53-0311	NO
1102-53-0312	NO
1102-53-0313	NO
1102-53-0314	NO
1102-53-0315	YES
1102-53-0316	YES
1102-53-0317	YES
1102-53-0318	NO
1102-53-0319	YES

1102-53-04XX

PART NUMBER	RoHS COMPLIANT
1102-53-0410	YES
1102-53-0411	NO
1102-53-0412	NO
1102-53-0413	NO
1102-53-0414	NO
1102-53-0415	YES
1102-53-0416	YES
1102-53-0417	YES
1102-53-0418	NO
1102-53-0419	YES

1102-53-044XX

PART NUMBER	RoHS COMPLIANT
1102-53-04410	YES
1102-53-04411	NO
1102-53-04412	NO
1102-53-04413	NO
1102-53-04414	NO
1102-53-04415	YES
1102-53-04416	YES
1102-53-04417	YES
1102-53-04418	NO
1102-53-04419	YES

1102-53-05XX

PART NUMBER	RoHS COMPLIANT
1102-53-0510	NO
1102-53-0511	NO
1102-53-0512	NO
1102-53-0513	NO
1102-53-0514	NO
1102-53-0515	NO
1102-53-0516	NO
1102-53-0517	NO
1102-53-0518	NO
1102-53-0519	NO

1102-53-088XX

PART NUMBER	RoHS COMPLIANT
1102-53-08810	NO
1102-53-08811	NO
1102-53-08812	NO
1102-53-08813	NO
1102-53-08814	NO
1102-53-08815	NO
1102-53-08816	NO
1102-53-08817	NO
1102-53-08818	NO
1102-53-08819	NO

TOOLING:

INSTALLATION TOOL: ARBOR PRESS	INSTALLATION TOOL: ANVIL (ARBOR PRESS OPERATED)	INSTALLATION TOOL: PRESS-FIT / ROLL SWAGE / RIVET PUNCH (ARBOR PRESS OPERATED)	INSTALLATION TOOL: PRESS-FIT (HAND OPERATED)
TM1	TA1102-53	TPI1102-53	TTI1102-53

NOTES:

DATASHEET NOTES
-----------------

N/A

INSTRUCTION NOTES
-------------------

SEE GENERAL PRESS FIT INSTALLATION INSTRUCTION ON CONCORD ELECTRONICS' WEBSITE [WWW.CONCORD-ELECTRONICS.COM](http://WWW.CONCORD-ELECTRONICS.COM).