

<b>DRAWING NUMBER:</b>	<b>1128-07-XXXX</b>
<b>PRODUCT GROUP:</b>	PC JACKS
<b>SUB-GROUP:</b>	INSULATED PC JACKS
<b>DESCRIPTION:</b>	TEST POINT INSULATED JACK - VERTICAL MOUNT

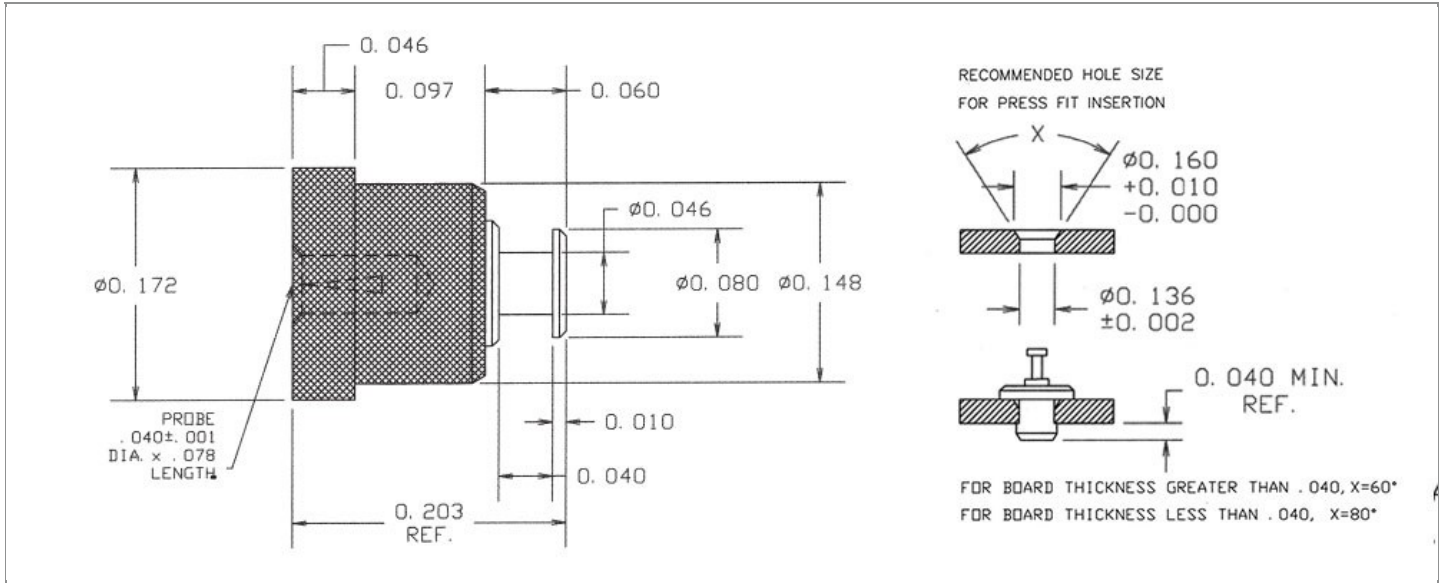

ACCEPTS PIN / PLUG / JACK SIZE	OVERALL LENGTH	MIN. HOLE DEPTH	MOUNTING ORIENTATION
0.040" ± 0.001	0.203"	0.078"	VERTICAL
BOARD / PANEL MOUNTING METHOD	MOUNTING HOLE SIZE	BOARD / PANEL THICKNESS	FEED THRU COMBINATION
PRESS FIT	0.136" ± 0.002	1/32" - 1/16"	JACK/TURRET

**PART NO. STRUCTURE:**

<b>1128</b>	-	<b>07</b>	-	<b>XX</b>	<b>XX</b>
PART SERIES		DIMENSION		FINISH	INSULATION COLOR

**MATERIAL OPTIONS:**

**1128-07-XXXX**

COMPONENT	MATERIAL	MATERIAL AND SPECIFICATION
BODY	N/A	N/A
SPRING (CAGE)	BERYLLIUM COPPER	BERYLLIUM COPPER PER ASTM B196, ALLOY C17300
INSULATION*	PTFE	PTFE PER ASTM D1710
MOUNTING BRACKET	N/A	N/A

\*For Insulation color, please see INSULATION COLOR OPTIONS on Page 2

FINISH - PLATING OPTIONS:

1128-07-XXXX

FINISH CODE	COMPONENT	FINISH	FINISH AND SPECIFICATION
03	BODY	N/A	N/A
	SPRING (CAGE)	GOLD	0.000010"MIN. GOLD PER ASTM B488, TYPE II, CODE C OVER 0.000100"MIN. NICKEL PER SAE-AMS-QQ-N-290, CLASS 2
	MOUNTING BRACKET	N/A	N/A
035	BODY	N/A	N/A
	SPRING (CAGE)	GOLD	0.000050"MIN. GOLD PER ASTM B488, TYPE II, CODE C OVER 0.000100"MIN. NICKEL PER SAE-AMS-QQ-N-290, CLASS 2
	MOUNTING BRACKET	N/A	N/A

INSULATION COLOR OPTIONS:

1128-07-XXXX

INSULATION COLOR	BLACK	BLUE	BROWN	GRAY	GREEN	ORANGE	RED	VIOLET	WHITE	YELLOW
COLOR CODE NO.	10	16	11	18	15	13	12	17	19	14

TOLERANCES:\*

DECIMAL	FRACTIONAL	ANGULAR	DRAWING ORIGATION DATE	LAST MODIFICATION DATE
± 0.005	± 1/64	± 5 °	6/22/2000	1/1/2017

\*All dimensions are in inches.

RoHS COMPLIANCE:

1128-07-03XX

PART NUMBER	RoHS COMPLIANT
1128-07-0310	YES
1128-07-0311	NO
1128-07-0312	NO
1128-07-0313	NO
1128-07-0314	NO
1128-07-0315	YES
1128-07-0316	YES
1128-07-0317	YES
1128-07-0318	NO
1128-07-0319	YES

1128-07-035XX

PART NUMBER	RoHS COMPLIANT
1128-07-03510	YES
1128-07-03511	NO
1128-07-03512	NO
1128-07-03513	NO
1128-07-03514	NO
1128-07-03515	YES
1128-07-03516	YES
1128-07-03517	YES
1128-07-03518	NO
1128-07-03519	YES

MILITARY REFERENCE SPECIFICATIONS:

1128-07-03XX

PART NUMBER	MIL SPECIFICATION	MIL PART NUMBER
1128-07-0310	N/A	N/A
1128-07-0311	N/A	N/A
1128-07-0312	N/A	N/A
1128-07-0313	N/A	N/A
1128-07-0314	N/A	N/A
1128-07-0315	N/A	N/A
1128-07-0316	N/A	N/A
1128-07-0317	N/A	N/A
1128-07-0318	N/A	N/A
1128-07-0319	N/A	N/A

1128-07-035XX

PART NUMBER	MIL SPECIFICATION	MIL PART NUMBER
1128-07-03510	N/A	N/A
1128-07-03511	N/A	N/A
1128-07-03512	N/A	N/A
1128-07-03513	N/A	N/A
1128-07-03514	N/A	N/A
1128-07-03515	N/A	N/A
1128-07-03516	N/A	N/A
1128-07-03517	N/A	N/A
1128-07-03518	N/A	N/A
1128-07-03519	N/A	N/A

TOOLING:

INSTALLATION TOOL: ARBOR PRESS	INSTALLATION TOOL: ANVIL (ARBOR PRESS OPERATED)	INSTALLATION TOOL: PRESS-FIT / ROLL SWAGE / RIVET PUNCH (ARBOR PRESS OPERATED)	INSTALLATION TOOL: PRESS-FIT (HAND OPERATED)	CRIMPING TOOL (COMMERCIAL VERSION)
TM1	TA1128-07	TPP1128-07	TTJ1128-07	N/A

NOTES:

<b>DATASHEET NOTES</b>
------------------------

N/A

<b>INSTRUCTION NOTES</b>
--------------------------

SEE GENERAL PRESS FIT INSTALLATION INSTRUCTION ON CONCORD ELECTRONICS' WEBSITE [WWW.CONCORD-ELECTRONICS.COM](http://WWW.CONCORD-ELECTRONICS.COM)