

DRAWING NUMBER:	1100-48-XXXX
PRODUCT GROUP:	TERMINALS
SUB-GROUP:	COMMERCIAL INSULATED TERMINALS
DESCRIPTION:	PTFE INSULATED PIN TERMINAL

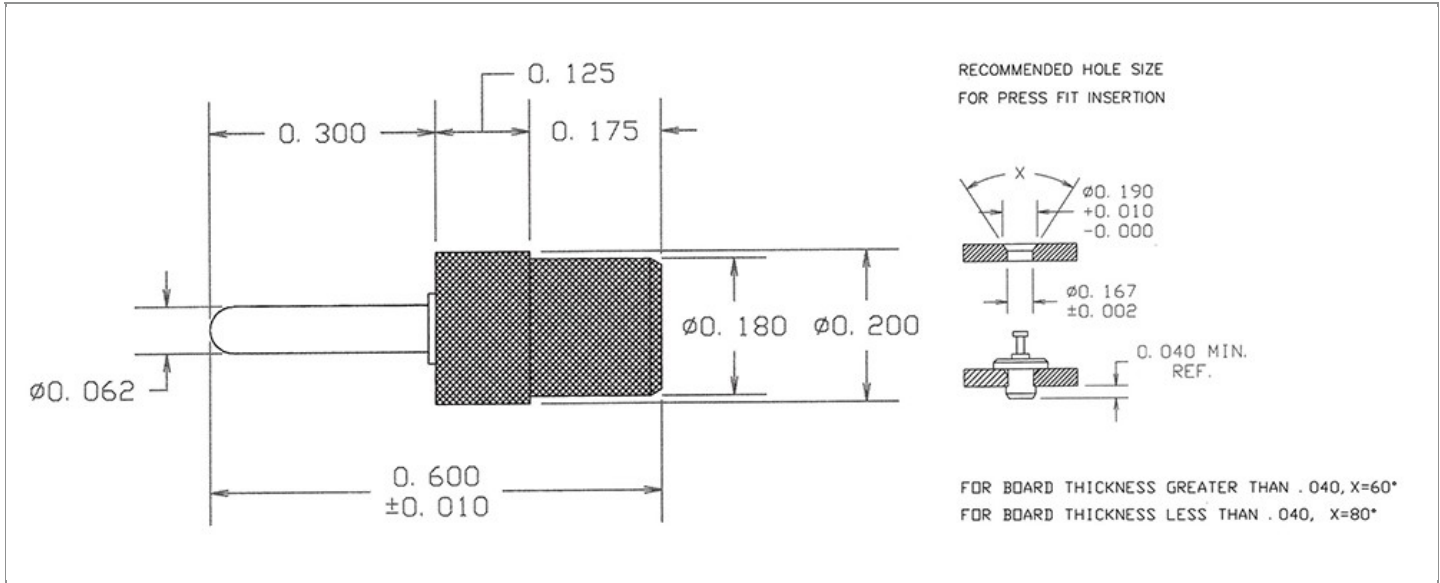

OVERALL LENGTH	PIN DIAMETER	FEED THRU COMBINATION	BOARD / PANEL MOUNTING METHOD
0.600"	0.062" ± 0.005	N/A	PRESS FIT

SHANK LENGTH (L)	BOARD / PANEL THICKNESS	MOUNTING HOLE SIZE	DRILL SIZE
N/A	UP TO 1/8"	0.167" ± 0.002	#19

PART NO. STRUCTURE:

1100	-	48	-	XX	XX
PART SERIES		DIMENSION		FINISH	INSULATION COLOR

MATERIAL OPTIONS:

1100-48-XXXX

COMPONENT	MATERIAL	MATERIAL AND SPECIFICATION
TERMINAL	BRASS	BRASS PER ASTM B16, ALLOY C36000, 1/2 HARD
BASE/METAL SLEEVE	N/A	N/A
INSULATION*	PTFE	PTFE PER ASTM D1710
NUT	N/A	N/A
WASHER	N/A	N/A

*For Insulation color, please see INSULATION COLOR OPTIONS on Page 3

FINISH - PLATING OPTIONS:

1100-48-XXXX

FINISH CODE	COMPONENT	FINISH	FINISH AND SPECIFICATION
01	TERMINAL	SILVER	0.000300"MIN. SILVER PER ASTM B700, TYPE 2, GRADE D WITH A NON-CHROMATE PRESERVATIVE TREATMENT
	BASE/METAL SLEEVE	N/A	N/A
	NUT	N/A	N/A
	WASHER	N/A	N/A
03	TERMINAL	GOLD	0.00010"MIN. GOLD PER ASTM B488, TYPE II, CODE C OVER 0.000100"MIN. NICKEL PER SAE-AMS-QQ-N-290
	BASE/METAL SLEEVE	N/A	N/A
	NUT	N/A	N/A
	WASHER	N/A	N/A
04	TERMINAL	ELECTRO-TIN	0.000300"MIN. ELECTRO-TIN PER ASTM B545 OVER 0.000100"MIN. NICKEL PER SAE-AMS-QQ-N-290
	BASE/METAL SLEEVE	N/A	N/A
	NUT	N/A	N/A
	WASHER	N/A	N/A
044	TERMINAL	BRIGHT ELECTRO-TIN	0.000300"MIN. BRIGHT ELECTRO-TIN PER ASTM B545 OVER 0.000100"MIN. NICKEL PER SAE-AMS-QQ-N-290
	BASE/METAL SLEEVE	N/A	N/A
	NUT	N/A	N/A
	WASHER	N/A	N/A
05	TERMINAL	ELECTRO-SOLDER	0.000300"MIN. ELECTRO-SOLDER PER SAE-AMS-P-81728 OVER 0.000100"MIN. NICKEL PER SAE-AMS-QQ-N-290
	BASE/METAL SLEEVE	N/A	N/A
	NUT	N/A	N/A
	WASHER	N/A	N/A
088	TERMINAL	BRIGHT TIN-LEAD	0.000300"MIN. BRIGHT TIN-LEAD (Sn93%-Pb7%) PER ASTM B545 OVER 0.000100"MIN. NICKEL PER SAE-AMS-QQ-N-290
	BASE/METAL SLEEVE	N/A	N/A
	NUT	N/A	N/A
	WASHER	N/A	N/A

INSULATION COLOR OPTIONS:

1100-48-XX **XX**

INSULATION COLOR	BLACK	BLUE	BROWN	GRAY	GREEN	ORANGE	RED	VIOLET	WHITE	YELLOW
COLOR CODE NO.	10	16	11	18	15	13	12	17	19	14

TOLERANCES:*

DECIMAL	FRACTIONAL	ANGULAR	DRAWING ORIGATION DATE	LAST MODIFICATION DATE
± 0.005	± 1/64	± 5 °	6/13/2000	3/1/2017

*All dimensions are in inches.

RoHS COMPLIANCE:

1100-48-01XX

PART NUMBER	RoHS COMPLIANT
1100-48-0110	YES
1100-48-0111	NO
1100-48-0112	NO
1100-48-0113	NO
1100-48-0114	NO
1100-48-0115	YES
1100-48-0116	YES
1100-48-0117	YES
1100-48-0118	NO
1100-48-0119	YES

1100-48-03XX

PART NUMBER	RoHS COMPLIANT
1100-48-0310	YES
1100-48-0311	NO
1100-48-0312	NO
1100-48-0313	NO
1100-48-0314	NO
1100-48-0315	YES
1100-48-0316	YES
1100-48-0317	YES
1100-48-0318	NO
1100-48-0319	YES

1100-48-04XX

PART NUMBER	RoHS COMPLIANT
1100-48-0410	YES
1100-48-0411	NO
1100-48-0412	NO
1100-48-0413	NO
1100-48-0414	NO
1100-48-0415	YES
1100-48-0416	YES
1100-48-0417	YES
1100-48-0418	NO
1100-48-0419	YES

1100-48-044XX

PART NUMBER	RoHS COMPLIANT
1100-48-04410	YES
1100-48-04411	NO
1100-48-04412	NO
1100-48-04413	NO
1100-48-04414	NO
1100-48-04415	YES
1100-48-04416	YES
1100-48-04417	YES
1100-48-04418	NO
1100-48-04419	YES

1100-48-05XX

PART NUMBER	RoHS COMPLIANT
1100-48-0510	NO
1100-48-0511	NO
1100-48-0512	NO
1100-48-0513	NO
1100-48-0514	NO
1100-48-0515	NO
1100-48-0516	NO
1100-48-0517	NO
1100-48-0518	NO
1100-48-0519	NO

1100-48-088XX

PART NUMBER	RoHS COMPLIANT
1100-48-08810	NO
1100-48-08811	NO
1100-48-08812	NO
1100-48-08813	NO
1100-48-08814	NO
1100-48-08815	NO
1100-48-08816	NO
1100-48-08817	NO
1100-48-08818	NO
1100-48-08819	NO

TOOLING:

INSTALLATION TOOL: ARBOR PRESS	INSTALLATION TOOL: ANVIL (ARBOR PRESS OPERATED)	INSTALLATION TOOL: PRESS-FIT / ROLL SWAGE / RIVET PUNCH (ARBOR PRESS OPERATED)	INSTALLATION TOOL: PRESS-FIT (HAND OPERATED)
TM1	TA1100-48	TPI1100-48	TTI1100-48

NOTES:

DATASHEET NOTES

N/A

INSTRUCTION NOTES

SEE GENERAL PRESS FIT INSTALLATION INSTRUCTION ON CONCORD ELECTRONICS' WEBSITE WWW.CONCORD-ELECTRONICS.COM.